

OWNER'S/ OPERATOR'S MANUAL

MODEL NO.'s

SG-26A

SG-36A



CAUTION

For Safe Operation
Read Rules And
Instructions Carefully

SI NO LEEINGLES, PIDA AYUDA
A AIGUIEN QUE SI LO LEA
PARA QUE LE TRADUZCA LAS
MEDIDAS DE SEGURIDAD.

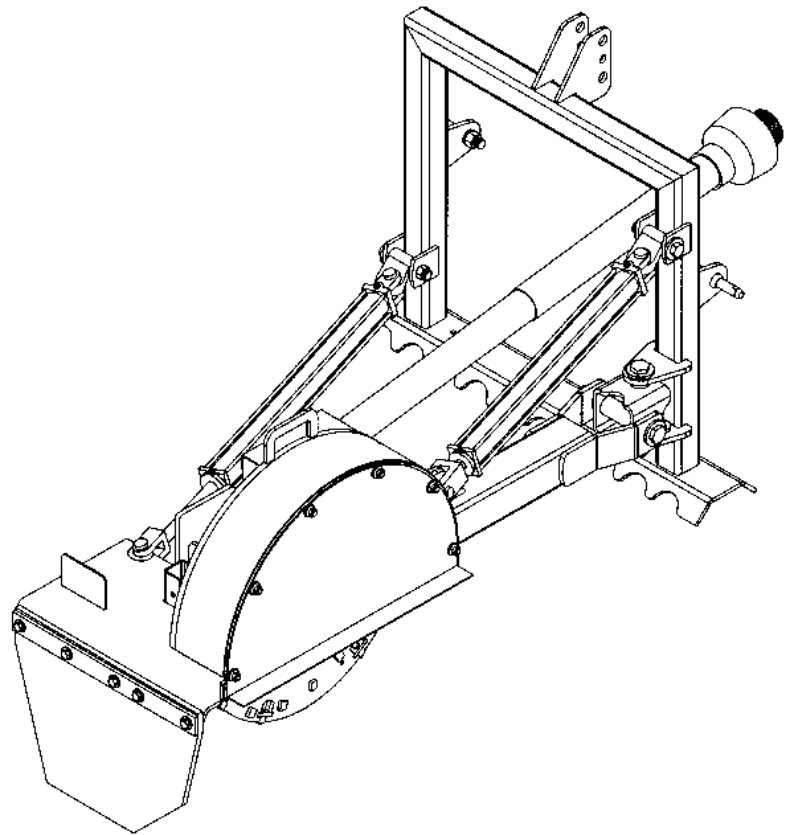

STUMP GRINDERS for **TRACTORS**

Safety Instructions
Tractor Preparation
Operating Instructions

Assembly & Mounting
Maintenance
Repair Parts

CAUTION

**THE FOLLOWING SAFETY PRECAUTIONS SHOULD BE THOROUGHLY UNDERSTOOD
BEFORE ATTEMPTING TO BEGIN ASSEMBLING THIS MACHINE**

1. Select an area for assembly that is clean and free of any debris which might cause persons working on the assembly to trip.
2. Do not lift heavy parts or assemblies. Use crane, jack, tackle, fork trucks or other mechanical devices.
3. Preview the assembly instructions in your operator's manual before proceeding further.
4. If the assembly instructions call for parts or assemblies to be blocked up, use only blocking material that is in good condition and is capable of handling the weight of the assembly to be blocked. Also insure that the blocking material is on a clean, dry surface.
5. Never put hands, or any part of body, under blocked up assemblies if at all possible.
6. After completing assembly, thoroughly inspect the machine to be sure that all nuts, bolts, hydraulic fittings or any other fastened assemblies have been thoroughly tightened.
7. Before operating the machine, thoroughly read the operation section of your operator's manual.
8. Before operating, read the maintenance section of your operator's manual to be sure that any parts requiring lubrication, such as gearboxes, are full, to avoid any possible damage.
9. **Before operating equipment – If you have any questions regarding the proper assembly or operation, contact your dealer or representative.**

TABLE OF CONTENTS

WARRANTY	2
SPECIFICATIONS	3
CHECKLISTS	4
SAFETY INFORMATION	5
SAFETY SIGNS	14
PREPARATION INSTRUCTIONS – TRACTOR	16
ASSEMBLY INSTRUCTIONS – TRACTOR	17
OPERATING INSTRUCTIONS	20
OWNER MAINTENANCE & LUBRICATION	25
TROUBLE-SHOOTING	28
PARTS LISTS	32

SI NO LEEINGLES, PIDA AYUDA A AIGUIEN QUE SI LO LEA PARA QUE LE TRADUZCA LAS MEDIDAS DE SEGURIDAD.

STATEMENT OF POLICY

It is the policy of Worksaver, Inc. to improve its products where it is possible and practical to do so. Worksaver, Inc. reserves the right to make changes or improvements in design and construction at any time, without incurring the obligation to make these changes on previously manufactured units.

TO THE OWNER:

Read this manual before using your Stump Grinder. This manual is provided to give you the necessary operating and maintenance instructions for keeping your Stump Grinder in top operating condition. Please read this manual thoroughly. Understand what each control is for and how to use it. Observe all safety signs on the machine and noted throughout the manual for safe operation of implement. Keep this manual handy for ready reference.

Like all mechanical products, it will require cleaning and upkeep. Lubricate the Stump Grinder as specified.

Use only genuine Worksaver, Inc. service parts. Substitute parts will void the warranty and may not meet standards required for safe and satisfactory operation. Record the model and serial number of your Stump Grinder here:

Model: _____ Serial Number: _____

RETAIL CUSTOMER'S RESPONSIBILITY

It is the Retail Customer and/or Operator's responsibility to read the Operator's Manual, to operate, lubricate, maintain, and store the product in accordance with all instructions and safety procedures. Failure of the operator to read the Operator's Manual is a misuse of this equipment.

It is the Retail Customer and/or Operator's responsibility to inspect the product and to have any part(s) repaired or replaced when continued operation would cause damage or excessive wear to other parts or cause a safety hazard.

It is the Retail Customer's responsibility to deliver the product to the authorized Worksaver Dealer, from whom he purchased it, for service or replacement of defective parts which are covered by warranty. Repairs to be submitted for warranty consideration must be made within forty-five (45) days of failure.

It is the Retail Customer's responsibility for any cost incurred by the Dealer for traveling to or hauling of the product for the purpose of performing a warranty obligation or inspection.

LIMITED WARRANTY



Worksaver warrants to the original purchaser of any new Stump Grinder (Models SG-26A and SG-36A), that the equipment be free from defects in material and workmanship for a period of one (1) year for non-commercial, state, and municipalities' use ninety (90) days for commercial use from date of retail sale.

Replacement or repair parts installed in the equipment covered by this warranty are warranted for ninety (90) days from the date of purchase of such part or to the expiration of the applicable new equipment warranty period, whichever occurs later.

Such parts shall be provided at no cost to the user during regular working hours. Worksaver reserves the right to inspect any equipment or parts which are claimed to have been defective in material or workmanship.

DISCLAIMER OF IMPLIED WARRANTIES & CONSEQUENTIAL DAMAGES

Worksaver's obligation under this warranty, to the extent allowed by law, is in lieu of all warranties, implied or expressed, including implied warranties of merchantability and fitness for a particular purpose and any liability for incidental and consequential damages with respect to the sale or use of the items warranted. Such incidental and consequential damages shall include but not be limited to: transportation charges other than normal freight charges; cost of installation other than cost approved by Worksaver; duty; taxes; charges for normal service or adjustments; loss of crops or any other loss of income; rental of substitute equipment, expenses due to loss, damage, detention or delay in the delivery of equipment or parts resulting from acts beyond the control of Worksaver.

THIS WARRANTY SHALL NOT APPLY:

1. To vendor items which carry their own warranties, such as hydraulic cylinders and hydraulic motor.
2. If the unit has been subjected to misapplication, abuse, misuse, negligence, fire or other accident.
3. If parts not made or supplied by Worksaver have been used in connection with the unit, if, in sole judgement of Worksaver such use affects its performance, stability, or reliability.
4. If the unit has been altered or repaired outside of an authorized Worksaver dealership in a manner which, in the sole judgement of Worksaver affects its performance, stability or reliability.
5. To normal maintenance service and normal replacement items such as gearbox lubricant, hydraulic fluid, worn blades, or to normal deterioration of such things as belts and exterior finish, due to use or exposure.
6. To expendable or wear items such as teeth, chains, sprockets, belts, springs and other items that in the company's sole judgement is a wear item.

NO EMPLOYEE OR REPRESENTATIVE OF WORKSAVER IS AUTHORIZED TO CHANGE THIS WARRANTY IN ANY WAY OR GRANT ANY OTHER WARRANTY UNLESS SUCH CHANGE IS MADE IN WRITING AND SIGNED BY WORKSAVER'S SERVICE MANAGER, POST OFFICE BOX 100, LITCHFIELD, ILLINOIS 62056-0100.



STUMP GRINDER SPECIFICATIONS

SUBJECT	MODEL SG-26A	MODEL SG-36A
Mounting	Cat. I - 3 pt.	Cat. I / II - 3 pt.
Recommended hp / Flow Req'd	22 - 45 PTO	45 - 100 PTO
# Hyd. Remote Outlets Reg.	2	2
Weight of Unit	660 lbs.	880 lbs.
Max Stump Height	18"	18"
Max Cutting Depth	10"	15"
Total Vertical Movement (Wheel)	28"	33"
Grinding Wheel Diameter	26"	36"
Grinding Wheel Speed (rpm)	810	788
Cutting Wheel Tip Speed (ft./min.)	5,515	7,430
Cutting Arc (degrees)	45°	45°
# Cutting Teeth	33	42
Gearbox Ratio	1:1.5	1:1.46
Gearbox (hp rating)	60 hp	100 hp
Input rpm	540 rpm	540 rpm
Output rpm	810	788
Gearbox Warranty	Limited 1 year	Limited 1 year
Gearbox Lubrication	90 w/ gear oil	90 w/ gear oil
PTO Driveline (Metric Series)	Metric Series 5	Metric Series 6
PTO Driveline Length (closed)	50"	54 ¹ / ₄ "
Swing Cylinder (Hyd.)	2" x 24"	2" x 24"
Depth Cylinder (Hyd.)	2 ¹ / ₂ " x 10"	2 ¹ / ₂ " x 10"

CHECKLISTS

DELIVERY CHECKLIST

Inspect the stump grinder thoroughly after assembly to be certain it is set up properly. The following checklist is a reminder of points to inspect. Check off each item as it is found satisfactory or after proper adjustment is made.

- Check operator's manual and familiarize the operator with all sections of it.
- Check that all safety shielding is in place.
- Check all bolts to be sure they are tight or adjusted properly at hinged locations.
- Check that all cotter pins are properly installed.
- Check PTO driveline. Make sure it is the correct length to operate stump grinder with intended tractor.
- Check that all lubrication points with grease fittings have been lubricated.
- Check that carbide teeth have been properly installed. Check all cutting tooth bolts.
- Check stump grinder attitude, after mounting on tractor.
- Check that gearbox is properly serviced and seals are not leaking.
- All safety signs (decals) in place and readable.
- When the stump grinder is transported on a road or highway at night or during the day, safety devices should be used for adequate warning to operators of other vehicles.

DAILY CHECKLIST

- Check that stump grinder is properly and securely attached to tractor.
- During inspection, check that all nuts and bolts are secure and that all safety shields are in place.
- It is very important that the cutting teeth and cutting tooth bolts are checked and tightened frequently.
- Check condition of grinding wheel and security of attachment.
- Do not put stump grinder into service unless cutting teeth edges are intact and in good repair.
- Do not put stump grinder into service unless all shields and guards are in place and in good condition. Replace if damaged.
- Make sure spring-activated locking pin or collar slides freely and is seated firmly in tractor PTO spline groove.
- Consult local utilities before working. Know location of all underground cables, pipelines, overhead wires, and other hazards in working area and avoid contact.
- Always wear relatively tight and belted clothing to avoid entanglement in moving parts. Wear sturdy, rough-soled work shoes and protective equipment for eyes, hair, hands, hearing, and head.

IMPORTANT!

Gearbox was not filled at factory. It must be serviced before operating. Fill to proper level with SAE 90 oil. Failure to service will result in damage to gearbox.

To the Owner/Operator/Dealer

All implements with moving parts are potentially hazardous. There is no substitute for a cautious, safe-minded operator who recognizes the potential hazards and follows reasonable safety practices. The manufacturer has designed this implement to be used with all its safety equipment properly attached to minimize the chance of accidents.

BEFORE YOU START!!

**Read the safety messages on the implement and shown in your manual.
Observe the rules of safety and common sense!**





THIS SYMBOL MEANS

- ATTENTION!
- BECOME ALERT!
- YOUR SAFETY IS INVOLVED!

THIS SAFETY ALERT SYMBOL IDENTIFIES IMPORTANT SAFETY WARNING MESSAGES. CAREFULLY READ EACH WARNING MESSAGE THAT FOLLOWS. FAILURE TO UNDERSTAND AND OBEY A SAFETY WARNING, OR RECOGNIZE A SAFETY HAZARD, COULD RESULT IN AN INJURY OR DEATH TO YOU OR OTHERS AROUND YOU. THE OPERATOR IS ULTIMATELY RESPONSIBLE FOR THE SAFETY OF HIMSELF, AS WELL AS OTHERS, IN THE OPERATING AREA OF THE TRACTOR AND EQUIPMENT.

UNDERSTAND SIGNAL WORDS

 **DANGER** Indicates an imminently hazardous situation that, if not avoided, WILL result in DEATH OR VERY SERIOUS INJURY.

 **WARNING** Indicates a imminently hazardous situation that, if not avoided, COULD result in DEATH OR SERIOUS INJURY.

 **CAUTION** Indicates a imminently hazardous situation that, if not avoided, MAY result in MINOR INJURY.

IMPORTANT Identifies special instructions or procedures that, if not strictly observed, could result in damage to, or destruction of the machine, attachments or the environment.

NOTE: *Identifies points of particular interest for more efficient and convenient operation or repair.*

If you have questions not answered in this manual or require additional copies or the manual is damaged, please contact your dealer or the manufacturer directly.

IMPORTANT SAFETY INFORMATION!

Working with equipment can lead to injuries. Read this manual, and the manual for your tractor, before assembly or operating, to acquaint yourself with the machines. It is the implement owner's responsibility, if this machine is used by any person other than yourself, is loaned or rented, to make certain that the operator, prior to operating:

1. Reads and understands the operator's manuals.
2. Is instructed in safe and proper use.

 The use of this equipment is subject to certain hazards which cannot be protected against by mechanical means or product design. All operators of this equipment must read and understand this entire manual, paying particular attention to safety and operating instructions, prior to using. If there is something in this manual you do not understand, ask your supervisor, or your dealer, to explain it to you.

SAFETY INSTRUCTIONS (continued)



EQUIPMENT SAFETY GUIDELINES



Safety of the operator is one of the main concerns in designing and developing a new piece of equipment. Designers and manufacturers build in as many safety features as possible. However, every year many accidents occur which could have been avoided by a few seconds of thought and a more careful approach to handling equipment. You, the operator, can avoid many accidents by observing the following precautions in this section. To avoid personal injury, study the following precautions and insist those working with you, or for you, follow them.



Personal protection equipment including hard hat, safety glasses, safety shoes, and gloves are recommended during assembly, installation, operation, adjustment, maintaining, repairing, removal, or moving the implement. Do not allow long hair, loose fitting clothing or jewelry to be around moving parts.



Replace any CAUTION, WARNING, DANGER or instruction safety sign that is not readable or is missing. Location of such safety signs is indicated in this booklet. Do not paint over, remove or deface any safety signs or warning signs on your equipment. Observe all safety signs and practice the instruction on them.



Never use alcoholic beverages or drugs which can hinder alertness or coordination while operating this equipment. Consult your doctor about operating this machine while taking prescription medications.



Review the safety instructions with all users annually.



This equipment is dangerous to children and persons unfamiliar with its operation. The operator should be a responsible adult familiar with farm machinery and trained in this equipment's operations. **Do not allow persons to operate or assemble this unit until they have read this manual and have developed a thorough understanding of the safety precautions and of how it works.**



To prevent injury or death, use a tractor equipped with a Roll-Over Protective System (ROPS). **Keep foldable ROPS systems in "locked up" position at all times. Keep seat belt fastened.**



Never exceed the limits of a piece of machinery. If its ability to do a job, or to do so safely, is in question – **DON'T TRY IT.**



Do not modify the equipment in any way. Unauthorized modification may impair the function and/or safety and could affect the life of the equipment.





In addition to the design and configuration of this implement, including safety signs and safety equipment, hazard control and accident prevention are dependent upon the awareness, concern, prudence, and proper training of personnel involved in the operation, transport, maintenance, and storage of the machine. Refer also to safety messages and operation instructions in each of the appropriate sections of the tractor and stump grinder manuals. Pay close attention to the safety signs affixed to the tractor and the stump grinder.

SAFETY INSTRUCTIONS (continued)





PREPARATION

-  Never operate the tractor or stump grinder until you have read and completely understand this manual, the tractor operator's manual, and each of the safety messages found on the safety signs on the tractor or stump grinder.

-  Make sure that all operating and service personnel know that in the event hydraulic fluid penetrates the skin, it must be surgically removed within a few hours by a physician familiar with this form of injury, or gangrene may result.

-  Consult local utility companies (Call 811) to make certain there are no buried gas lines, electrical cables, etc., in the work area before beginning operation.

-  **PROLONGED EXPOSURE TO LOUD NOISE MAY CAUSE PERMANENT HEARING LOSS!**
Power units with or without implements attached can often be noisy enough to cause permanent, partial hearing loss. We recommend that you wear hearing protection on a full-time basis if the noise in the Operator's position exceeds 80db. Noise over 85db on a long-term basis can cause severe hearing loss. Noise over 90db adjacent to the Operator over a long-term basis may cause permanent, total hearing loss. **NOTE:** Hearing loss from loud noise (from tractors, chain saws, radios, and other such sources close to the ear) is cumulative over a lifetime without hope of natural recovery.

-  Operate the stump grinder only with a tractor equipped with an approved Roll-Over Protective System (ROPS). Always wear your seat belt on tractors equipped with a ROPS. Serious injury or even death could result from falling off the tractor – particularly during a turnover when the operator could be pinned under the ROPS or the tractor. Keep foldable ROPS systems in “locked up” position at all times.

-  Clear area where stump is to be cut of stones, branches or other debris that might be thrown, causing injury or damage. Before starting machine, remove loose chunks of wood or other objects from stump and work area.

-  Operate only in daylight or good artificial light.

-  Ensure stump grinder is properly mounted, adjusted and in good operating condition.

-  Make sure driveline spring-activated locking pin or balls operate freely and are seated firmly in tractor PTO stub shaft groove.

-  Ensure that all safety shielding and safety signs are properly installed and in good condition.

SAFETY INSTRUCTIONS (continued)



STARTING AND STOPPING SAFETY



PTO powered stump grinder's operating power is supplied from tractor PTO. Refer to your tractor manual for PTO engagement and disengagement instructions. Always operate PTO at 540 RPM. Know how to stop tractor and stump grinder quickly in case of an emergency.



Start tractor only when properly seated in the tractor seat. Starting a tractor in gear can result in injury or death. Do not mount or dismount the tractor while the tractor is moving. Mount or dismount the tractor only when the tractor and all moving parts are completely stopped.



When engaging PTO, the engine RPM should always be low. Once engaged and ready to start cutting, raise PTO speed to 540 RPM and maintain throughout stump grinding operation.



Check the tractor master shield over the PTO stub shaft. Make sure it is in good condition and fastened securely to the tractor. Purchase a new shield if old shield is damaged or missing. (You may have to use a tractor salvage yard for replacement parts on older tractors.)



The addition of a separate over-running PTO clutch attachment will change the length of the PTO driveline. Pay extra attention to the instructions on PTO driveline installation.

Separate over-running clutch attachments will increase the length of the driveline and may cause the front knuckle joint to operate beyond the cover of the tractor master shield. This is NOT recommended and will present a dangerous operating condition.



OPERATIONAL SAFETY

The use of this equipment is subject to certain hazards which cannot be protected against by mechanical means or product design. All operators of this equipment must read and understand this entire manual, paying particular attention to safety and operating instructions, prior to using. If there is something in this manual you do not understand, ask your supervisor, or your dealer, to explain it to you.



Keep all helpers and bystanders at least a hundred feet (100 ft.) from an operating stump grinder. Only properly trained people should operate this machine.

















The majority of accidents involve entanglement on the driveline, injury of bystanders by objects thrown by the grinding wheel, and operators being knocked off the tractor by low hanging limbs and then being run over by the equipment. Accidents are most likely to occur with machines that are loaned or rented to someone who has not read the owner's manual and is not familiar with a stump grinder.

SAFETY INSTRUCTIONS (continued)



OPERATIONAL SAFETY (continued)

-  Always stop the power unit, set brake, shut off the engine, remove the ignition key, lower implement to the ground and allow grinding wheel to come to a complete stop before dismounting. Never leave equipment unattended with the power unit running.
-  Never place hands or feet under stump grinder with power unit engine running or before you are sure all motion has stopped. Stay clear of all moving parts. Keep hands, feet, hair, and clothing away from moving parts.
-  Do not reach or place yourself under equipment until it is blocked securely.
-  Take all possible precautions when leaving unit unattended: Disengage PTO, set parking brake, stop engine and remove key from ignition. Park in level area.
-  Do not allow riders on the stump grinder or power unit at any time. There is no safe place for any riders.
-  Disengage power takeoff (PTO) or hydraulic power and place transmission into neutral before attempting to start engine.
-  Do not operate unless all personnel, livestock, and pets are a hundred feet away to prevent injury by thrown objects. Never direct discharge toward anyone.
-  Install and secure all guards and shields before starting or operating.
-  PTO powered stump grinders are designed for use only on tractors with 540 RPM power takeoff.
-  Never operate tractor and stump grinder under trees with low hanging limbs. Operators can be knocked off the tractor and then run over by the equipment.
-  Frequently check cutting teeth. They should be sharp, free of nicks and cracks and securely fastened.
-  The rotating parts of this machine have been designed and tested for rugged use. However, they could fail upon impact with heavy, solid objects such as steel posts, and other hard foreign material. Such impact could cause the broken objects to be thrown outward at very high velocities. To reduce the possibility of property damage, serious injury, or even death, try to never allow the grinding wheel to contact such obstacles. Trees will sometimes grow around foreign objects so they cannot always be seen. Be extra cautious when grinding tree stumps near buildings or in fence rows.
-  Many varied objects, such as wire, cable, rope, or chains, can become entangled in the grinding wheel. These items could then swing outside the housing at great velocities. Such a situation is extremely hazardous. Inspect the cutting area for such objects before grinding stumps. Removing any like object from the site. Never allow the grinding wheel to contact such items.
-  Pick up all rocks and other debris before grinding stumps. Enter new areas carefully. Never assume an area is clear. **Always Check!**

SAFETY INSTRUCTIONS (continued)



OPERATIONAL SAFETY (continued)



Stop stump grinder and power unit immediately upon striking an obstruction. Turn engine off, remove key, inspect and repair any damage before resuming operation.



The guards, flaps, driveline shields, and gearbox shields should be used and maintained in good working condition. They should be inspected carefully, at least daily, for missing or broken shields, or guards. Missing broken, or worn items must be replaced at once to reduce the possibility of injury from thrown objects or entanglement.



Stay alert for holes, rocks and roots in the terrain and other hidden hazards. Keep away from drop-offs.



Use extreme care and maintain minimum ground speed when transporting on hillside, over rough ground and when operating close to ditches or fences. Be careful when turning sharp corners.



Reduce speed on slopes and sharp turns to minimize tipping or loss of control. Be careful when changing directions on slopes. Do not start or stop suddenly on slopes. Avoid operation on steep slopes.



When using a tractor mounted unit, a minimum 20% of tractor and equipment weight must be on tractor front wheels. Without this weight, tractor could tip over, causing personal injury or death. The weight may be attained with a front end loader, front wheel weights, ballast in tires or front tractor weights. When attaining a minimum 20% of tractor and equipment weight on the front wheels, you must not exceed the ROPS weight certification. Weigh the tractor and equipment. Do not guess or estimate!



Inspect the entire machine periodically as indicated in the Maintenance Section of this manual. Look for loose fasteners, worn or broken parts, pinched hydraulic hoses, and leaky or loose fittings. Make sure all pins have cotter pins and washers. Serious injury may occur from not maintaining this machine in good working order.



Be careful when operating power unit and stump grinder on uneven ground to avoid upsetting.



In extremely uneven terrain, rear wheel weights, front tractor weight, and/or tire ballast should be used to improve stability.



Pass diagonally through sharp dips and avoid sharp drops to prevent “hanging up” power unit and stump grinder. Practice will improve your skills in maneuvering rough terrain.

















Avoid sudden starts and stops while traveling up or downhill.

SAFETY INSTRUCTIONS (continued)



TRANSPORT SAFETY

-  Comply with state and local laws governing highway safety and movement of farm machinery on public roads.
-  The use of flashing amber lights is acceptable in most localities. However, some localities prohibit their use. Local laws should be checked for all highway lighting and marking requirements.
-  When driving the tractor and equipment on the road or highway under 20 mph (32 kph) at night or during the day, use flashing amber warning lights and a slow moving vehicle (SMV) identification emblem.
-  Always be sure the implement is in the proper raised position for transport.
-  Reduce speed when transporting mounted implements to avoid bouncing and momentary loss of steering control.
-  Plan your route to avoid heavy traffic.
-  Always install transport locks, pins or brackets before transporting.
-  Do not drink and drive!
-  Watch for traffic when operating near or crossing roadways.
-  Turn curves or go up or down hills only at a low speed and at a gradual steering angle. Make certain that at least 20% of the tractor's weight is on the front wheels to maintain safe steerage. Slow down on rough or uneven surfaces, and loose gravel.
-  Use extreme care and maintain minimum ground speed when transporting on hillside, over rough ground and when operating close to ditches or fences. Be careful when turning sharp corners.
-  Never allow riders on either power unit or stump grinder. Falling off can kill.
-  Be a safe and courteous driver. Always yield to oncoming traffic in all situations, including narrow bridges, intersections, etc.
-  Do not exceed 20 mph (32 kph). Reduce speed on rough roads and surfaces.

SAFETY INSTRUCTIONS (continued)



MAINTENANCE SAFETY

Good maintenance is your responsibility. Poor maintenance is an invitation to trouble.



Before working on this machine, drive to a level area, disengage the PTO, lower implement (or if working underneath, raise and block securely), shut off the engine, set the brakes, and remove the ignition keys. Remove hydraulic pressure prior to doing any maintenance. Operate the remote hydraulic control lever in and out several times to relieve hydraulic pressure.



Be certain all moving parts on attachments have come to a complete stop before attempting to perform maintenance.



Never work under equipment unless it is blocked securely. Never depend on hydraulic system to keep implement in raised position.



Keep all persons away from operator control area while performing adjustments, service, or maintenance.



Always use personal protection devices such as eye, hand and hearing protectors, when performing any service or maintenance.



Frequently check carbide tipped cutting teeth. They should be sharp, free of nicks and cracks and securely fastened. Rotate teeth for even wear – outer teeth wear faster.



Periodically tighten all bolts, nuts and screws and check that all cotter pins are properly installed to ensure unit is in a safe condition.



When completing a maintenance or service function, make sure all safety shields and devices are installed before placing unit in service.



Never use your hands to locate a hydraulic leak on attachments. Use a small piece of cardboard or wood. Hydraulic fluid escaping under pressure can penetrate the skin.



Openings in the skin and minor cuts are susceptible to infection from hydraulic fluid. If injured by escaping hydraulic fluid, see a doctor at once. Gangrene and death can result. Without immediate medical treatment, serious infection and reactions can occur.



Check to ensure all safety signs are installed and in good condition.







Where replacement parts are necessary for periodic maintenance and servicing, genuine factory replacement parts must be used to restore your equipment to original specifications. The manufacturer will not claim responsibility for use of unapproved parts and/or accessories and other damages as a result of their use.

If equipment has been altered in any way from original design, the manufacturer does not accept any liability for injury or warranty.

SAFETY INSTRUCTIONS (continued)





STORAGE SAFETY

-  Following operation, or when unhooking, stop the tractor, set the brakes, lower ram to lowest position and engage transport lock pin, shut off the engine, relieve hydraulic pressure and remove the ignition keys.
-  Store the unit in an area away from human activity.
-  Do not park equipment where it will be exposed to livestock for long periods of time. Damage and livestock injury could result.
-  Do not permit children to play on or around the stored unit.
-  Make sure all parked machines are on a hard, level surface and engage all safety devices.
-  If blocking is used, make sure it is solid and secure before leaving area.



SAFETY SIGNS

-  Keep safety signs clean and legible at all times.
-  Replace safety signs that are missing or have become illegible.

Replaced parts that displayed a safety sign should also display the current sign.

Safety signs are available from your Distributor or Dealer Parts Department or the factory.

How to Install Safety Signs:

- Be sure that the installation area is clean and dry.
- Be sure temperature is above 50°F (10°C).
- Decide on the exact position before you remove the backing paper.
- Remove the smallest portion of the split backing paper.
- Align the sign over the specified area and carefully press the small portion with the exposed sticky backing in place.
- Slowly peel back the remaining paper and carefully smooth the remaining portion of the sign in place.
- Small air pockets can be pierced with a pin and smoothed out using the piece of sign backing paper.

SAFETY SIGNS

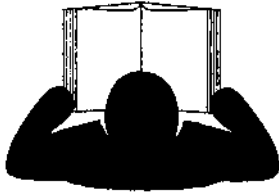
	<p>! WARNING</p> <p>To prevent Serious Injury or Death</p> <ul style="list-style-type: none"> • Avoid unsafe operation or maintenance. • Do not operate or work on this machine without reading and understanding the operator's manual. • If manual is lost, contact your nearest dealer for a new manual.
	<small>SW1</small>

<p>! DANGER</p>

<p>ROTATING DRIVELINE CONTACT CAN CAUSE DEATH KEEP AWAY!</p> <p>Do not operate without -</p> <ul style="list-style-type: none"> • All driveline, tractor and equipment shields in place. • Drivelines securely attached at both ends. • Driveline shields that turn freely on driveline.
<small>101103 SW101</small>

<p>! WARNING</p>	
	
<p>HIGH-PRESSURE FLUID HAZARD</p> <p>To prevent serious injury or death:</p> <ul style="list-style-type: none"> • Relieve pressure on system before repairing or adjusting or disconnecting. • Wear proper hand and eye protection when searching for leaks. Use wood or cardboard instead of hands. • Keep all components in good repair. 	
<small>SW700</small>	

<p>! WARNING</p>
<p>540 RPM SPEED RANGE ONLY</p> <p>HIGHER PTO SPEEDS CAN CAUSE PERSONAL INJURY AND EQUIPMENT FAILURE</p>
<small>101101</small>



<p>NOTICE!</p> <p>GEARBOX SHIPPED WITHOUT OIL</p> <p>Fill to proper level with EP-90 gear lubricant. READ operator's manual.</p>
<small>101188</small>

<p>! WARNING</p>
<p>Stand clear</p>
<small>101027</small>

BE CAREFUL! Use a clean, damp cloth to clean safety decals. Avoid spraying to close to decals when using a pressure washer; high-pressure water can enter through very small scratches or under edges of decals causing them to peel or come off.

REMEMBER: If Safety Signs have been damaged, removed, become illegible or parts replaced without Signs, new Safety Signs must be applied. New Safety Signs are available from your authorized distributor or factory.

SAFETY SIGNS (continued)

	
<h1>DANGER</h1>	
	
<ul style="list-style-type: none">● Flying debris and rotating wheel can cause injury or death.● Operate from tractor seat only.● Keep others at least 100 Ft. away from stump grinder when in operation.● Stop engine before cleaning or servicing.	
<small>101206</small>	

<h2>WARNING</h2>
<ul style="list-style-type: none">● Adjust relief valve only with stump grinder, hydraulic pressure, and tractor engine in the "off" position.● Always have the thumb wheel locked securely against the valve body prior to operation. Failure to do so may cause serious personal injury.
<small>101219</small>

BE CAREFUL! Use a clean, damp cloth to clean safety decals. Avoid spraying to close to decals when using a pressure washer; high-pressure water can enter through very small scratches or under edges of decals causing them to peel or come off.

REMEMBER: If Safety Signs have been damaged, removed, become illegible or parts replaced without Signs, new Safety Signs must be applied. New Safety Signs are available from your authorized distributor or factory.

INSTRUCTIONS

TRACTOR REQUIREMENTS AND PREPARATION

The models SG-26 and SG-36 PTO driven stump grinders are designed to mount on tractors that have a 3 pt. hitch and a 540 rpm PTO (power takeoff) in good working condition.

The model SG-26 requires a tractor of at least 22 hp or up to a maximum of 45 hp and a Category I, 3 pt. hitch.

The model SG-36 requires a tractor of at least 45 hp or up to a maximum of 100 hp and a Category I or II, 3 pt. hitch.

It is recommended that only tractors with wide front axles be used with these stump grinders. Tricycle front wheel arrangements are inherently unstable and tractor roll-over accidents are more likely to occur.

The tractor also needs lift arm stabilizer bars or sway blocks to control side movement of the stump grinder. Adjust as tightly as practical for best performance.

Check the tractor's 3 pt. hydraulic lift system. Refer to your tractor operator's manual or dealer for any adjustments necessary to put the hydraulic system in good working order. (I&T shop manuals will list most specifications and adjustment instructions – available from most farm equipment dealers.)

Tractor must be equipped with two (2) independent pair of remote hydraulic outlets to operate these stump grinders.

Be sure tires and rims are in good condition. Inflate tires to the proper recommended air pressure.

Check the tractor master shield over the PTO stub shaft. Make sure it is in good condition and fastened securely to the tractor. Purchase a new shield if old shield is damaged or missing. (You may have to use a tractor salvage yard for replacement parts on older tractors.)

It is recommended that a ROPS (Roll-Over Protection Structure) and a seat belt be installed on all tractors. Keep foldable ROPS systems in "locked up" position at all times. Contact your local dealer for a ROPS for your tractor.

Most swinging drawbars will have to be moved to a forward position or removed. Check the tractor swinging drawbar for interference with the front of the stump grinder. The swinging drawbar can be moved forward on some tractors or it can be removed.

CAUTION

Be sure your tractor is in good condition. Read all the safety precautions and make sure all tractor operators are familiar with the safety rules of operation.

The operator is responsible for the safe operation of this stump grinder. The operator must be properly trained. Operators should be familiar with the stump grinder and tractor and all safety practices before starting operation. Read the safety rules and safety signs on pages 5-15.

WARNING

When using the unit, a minimum 20% of tractor and equipment weight must be on tractor front wheels. Without this weight, tractor could tip up, causing possible loss of control and possible personal injury or death. The weight may be attained with a front end loader, front wheel weights, ballast in tires or front tractor weights. When attaining a minimum 20% of tractor and equipment weight on the front wheels, you must not exceed the ROPS weight certification. Weigh the tractor and equipment. **DO NOT GUESS OR ESTIMATE!**

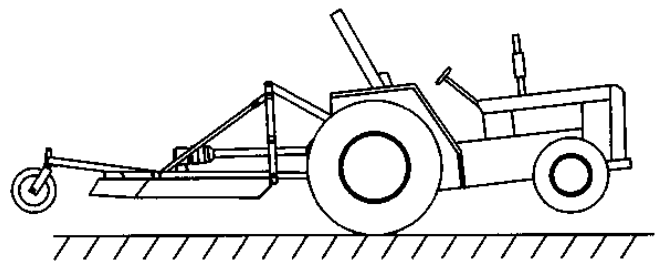

Figure 1. Tractor Stability

WARNING

A heavy load can cause instability in driving a tractor. Make sure the front of the tractor is properly counterbalanced with weights. Always drive slowly – especially around turns. An unstable tractor could steer badly and possibly tip over, causing injury or death.

INSTRUCTIONS (continued)

TRACTOR 3 PT. ASSEMBLY AND MOUNTING



CAUTION

To avoid bodily injury caused by accidental falling of stump grinder, securely support stump grinder on safe supporting stands or blocks!

This unit is shipped almost completely assembled. Carefully follow instructions for final assembly.

Before attempting assembly check the following items. Having all the needed parts and equipment readily at hand will speed up your assembly task and will make the job as safe as possible.

- Refer to the repair parts drawing in this manual to get an idea of how the parts need to be assembled for each individual implement model.
- Check for fasteners and pins that were shipped with the stump grinder. All hardware coming from the factory has been installed in the location where it will be used. If a part or fastener is temporarily removed for assembly reasons, remember where it goes. Keep the parts separated.
- Have a fork lift or loader along with chains and safety stands that are sized for the job ready for the assembly task.
- Have a minimum of 2 people at hand during assembly.
- Check to see that all nuts are tightened.

Never let anyone stand between the rear of the tractor and the stump grinder while the tractor is backing up. Always stand to the side until tractor has come to a complete stop and the brakes set or the tractor shift placed in "PARK."

- 1) Back tractor to align lift arms with stump grinder hitch points.
- 2) Attach both lower lift arms to stump grinder. Secure with linch pins. Tractor lift arm stabilizer bars or sway blocks must be used to control side movement of the stump grinder. **DO NOT CONNECT THE PTO DRIVELINE AT THIS TIME.**
- 3) Install suitable top link between tractor and stump grinder. Secure with link pins and linch pins.
- 4) Lift stump grinder and check to see that both 3 pt. lift arms are the same height. Adjust using crank if necessary to level the implement from side to side.

PTO DRIVELINE INSTALLATION

On new stump grinders, check PTO driveline for correct length for use with your tractor. (Read page 18.)

Most swinging drawbars will have to be moved to a forward position or removed. Check the tractor swinging drawbar for interference with the PTO driveline before attempting to lift the stump grinder with the 3 pt. hitch.

Tractor lift arm stabilizer bars or sway blocks must be used to control side movement of the stump grinder.

A new slip clutch, or one that has been in storage over the winter may seize. Before operating, make sure it will slip. Refer to slip clutch adjustment on page 27.

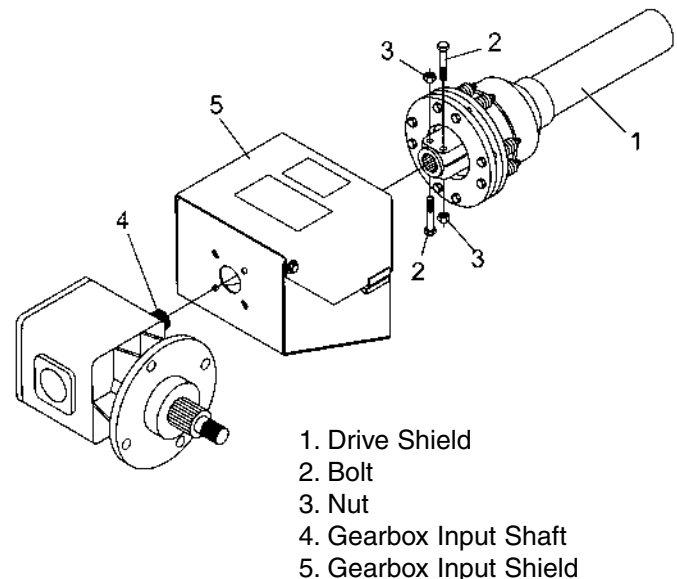

Figure 2. Slip Clutch Driveline Installation

Align the holes in the driveline yoke and the groove in the gearbox input shaft and install bolts (2) and nuts (3).

Lubricate rear driveline half and install front driveline half.

In some cases it will be necessary to shorten the PTO assembly to match your particular tractor. The following procedure should be used:

1. Raise the tractor 3 pt. hitch so the input shaft of the gearbox is in line with the PTO shaft on the tractor. Shut down tractor, leaving stump grinder in position of shortest distance between shafts. **SECURELY BLOCK IMPLEMENT IN POSITION.**

INSTRUCTIONS (continued)

SLIP CLUTCH DRIVELINE INSTALLATION (cont.)

2. Pull driveline apart. Attach outer (female) section to tractor PTO shaft. Pull on driveline section to be sure that yoke locks into place.
3. Hold driveline sections parallel to each other to determine if too long. Each section should end approximately 3" (76mm) short of reaching universal joint shield on opposite section. If too long, measure 3" (76mm) back from universal joint shield and mark on opposite section (Figure 3). Do this for both sections. **DO NOT CUT UNTIL STEPS 4 AND 5 ARE CHECKED.**

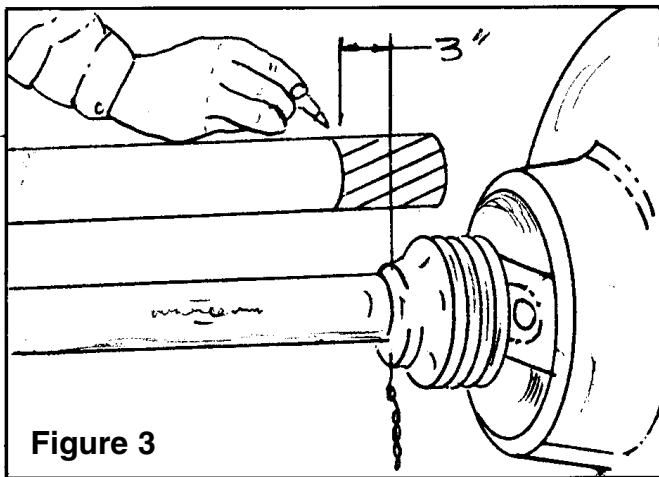

Figure 3

NOTE: The use of a PTO over-running clutch or extension could require that the PTO driveline be shortened a considerable amount. If this is done, the driveline halves may separate when the stump grinder is lowered to the ground or when operated on uneven ground.

NOTE: Because of the above situation, and the use of PTO extensions extend the front PTO driveline joint beyond the protection of the tractor PTO shield, the use of PTO extensions and over-running clutches of this type are not recommended.

4. Swing and lower the stump grinder wheel to determine position with greatest distance between the PTO shaft and gearbox input shaft. Shut tractor off, leaving stump grinder in position of greatest distance between shafts. **SECURELY BLOCK STUMP GRINDER IN POSITION.**

5. Hold driveline sections parallel to each other and check for **minimum 6" (15cm) overlap**. If driveline has been marked for cutting, overlap will be the distance between the two marks. If driveline has less than minimum overlap, do not use. Contact authorized Worksaver dealer.

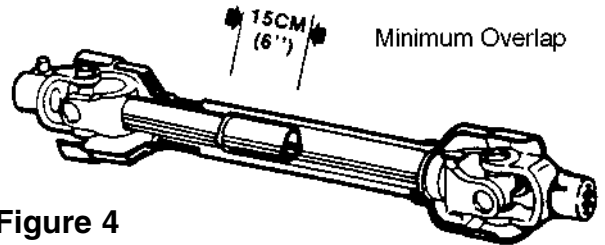

Figure 4

6. If driveline must be cut to a shorter length, clamp driveline in a well padded vise to prevent damage to the shield. Cut off shield where marked. Using cut-off section of shield as a guide, cut shaft the same amount. (Figure 5.)

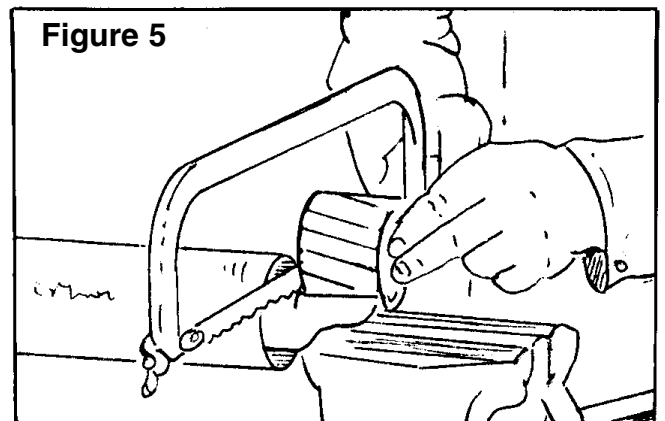

Figure 5

7. Repeat the procedure to the other driveline half. Remove all burrs and cuttings.
8. Apply multi-purpose grease to inside of outer (female) driveline section. Assemble driveline and install on tractor and stump grinder. Pull on each driveline section to be sure yokes lock into place. Make certain driveline shielding is in place and in good condition.
9. Carefully raise, lower, and swing the stump grinder wheel and check to be sure the PTO assembly does not jam. If it does, cut equal amounts from each half of the PTO assembly.

INSTRUCTIONS (continued)

SLIP CLUTCH DRIVELINE INSTALLATION (cont.)

10. Check the swinging drawbar of the tractor and make sure the PTO driveline assembly will not contact. The swinging drawbar can be moved forward on some tractors or it can be removed.

If the PTO driveline assembly contacts the swinging drawbar, damage will occur to the driveshaft shield and possibly the driveshaft itself. (NOT covered under warranty.)



WARNING

When attaching PTO yoke to tractor PTO shaft, it is important that spring-activated locking pin or balls operate freely and are seated in groove on PTO shaft. A loose shaft could slip off and result in personal injury or damage to equipment.

ASSEMBLY (continued)

Check the hydraulic hose routing and connections as shown in Figure 6. The hydraulic cylinder circuit that swings the stump grinder left to right has a pressure relief valve to control the side pressure. Connect this relief valve as shown.

Use a good thread sealant. (DO NOT USE TEFLON TAPE as this could cause hydraulic system problems in your tractor.)

The hydraulic circuits for both cylinders contain an orifice to provide a controllable rate of movement (#8).

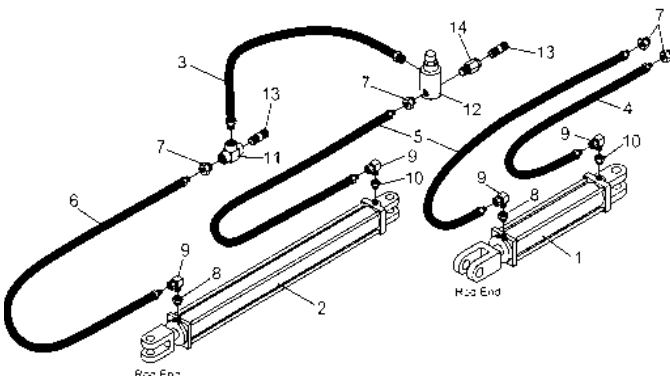

Figure 6. Stump Grinder Hydraulic Diagram

Route the hoses to your tractor remote hydraulic couplers. Be sure to allow a loop of hose just behind the attachment to allow for the angles that will be encountered. Make sure that the hoses are routed so they will not be pinched or snagged by implement or

tractor parts. Fasten the hoses securely so they will remain in the correct position and not drop down where they could be pinched or sheared.

After making the hose connection between the tractor remote outlets and the hydraulic cylinders, operate the cylinders several times to work the air out of the system.

Check hydraulic fluid level in your tractor after filling the cylinders and hoses.

NOTE: If your tractor has a **closed center** hydraulic system, turn the flow control on the remote hydraulic outlet block to minimum flow.

If your tractor does not have a flow control, contact Worksaver, Inc. for a restrictor orifice fitting to reduce the flow. This will minimize the heat build up in the tractor closed center hydraulic system.

Order optional throttle valve #2505642 for closed center systems (see page 32 for location).

INSTRUCTIONS



DANGER

Escaping hydraulic fluid under pressure can penetrate the skin, causing serious injury.

DO NOT use your hand to check for leaks. Use a piece of cardboard or paper to search for leaks.

Stop engine and relieve pressure before connecting or disconnecting lines.

Tighten all connections before starting engine or pressurizing lines.

If any fluid is injected into the skin, obtain medical attention immediately, or gangrene may result.

GEARBOX OIL FILL

NOTE: The gearbox is shipped WITHOUT lubricant, so it will be necessary to fill it before use. With the gearbox in a level position, fill to the side inspection hole with a good 90 wt. gear lubricant. Check often and add lubricant if necessary.

GEARBOX OIL CAPACITY

Model SG-26	2 pints
Model SG-36	6 pints

OPERATING INSTRUCTIONS

GENERAL SAFETY

Only qualified people familiar with this manual should operate this machine. Operator should wear hard hat, safety glasses, and safety shoes. It is recommended that tractor be equipped with Roll-Over Protective System (ROPS) and a seat belt be used. Before beginning operation, clear work area of objects that may be picked up and thrown. Always turn off engine, set parking brake, lower stump grinder to ground and allow cutting wheel to come to a complete stop before dismounting.

The designed and tested safety of this machine depends on it being operated within the limitations as explained in this manual. Be familiar with and follow all safety rules in the manual, on the stump grinder and on the power unit.



CAUTION

Read manual before operating.

The safe operation of this machine is the responsibility of the owner/operator. The operator should be familiar with the stump grinder, the power unit, and all safety practices before starting operation. Read the safety rules on pages 5 thru 15.



WARNING

Do not operate the PTO at other than the rated 540 RPM. Excessive speeds can cause breakage, thrown objects, and potential injury.



WARNING

A heavy load can cause instability in driving a tractor. Make sure the front of the tractor is properly counterbalanced with weights. Always drive slowly – especially around turns. An unstable tractor could steer badly and possibly tip over, causing injury or death.

PRE-OPERATION CHECKLIST

(OWNER RESPONSIBILITY)

- _____ Review and follow safety rules and safety signs on pages 5 through 15.
- _____ Check that stump grinder is properly and securely attached to tractor.
- _____ Make sure driveline spring-activated locking pin or locking balls operate freely and are seated firmly in tractor PTO spline groove.
- _____ Lubricate all grease fitting locations. Make sure PTO shaft slip joint is lubricated.
- _____ Check to be sure gear lube runs out the small check plug on side of gearbox.
- _____ Check that all hardware is properly installed.
- _____ Check to ensure cutting teeth are sharp and secure.
- _____ Check that all shields and guards are properly installed and in good condition.
- _____ Check stump grinder, front to rear attitude and top link adjustment.
- _____ Place tractor PTO and transmission in neutral before starting engine.
- _____ Set tractor PTO gear select lever for 540 rpm operation.
- _____ Inspect area and stump to be cut and remove stones, branches or other hard objects that might be thrown, causing injury or damage.
- _____ You should always wear a hard hat, work shoes, hearing protectors, and eye protection.
- _____ Check that no one enters the area of machine operation. Always keep bystanders at a safe distance from the stump grinder (100 ft. away).
- _____ Know your controls and how to stop tractor, engine and PTO quickly in an emergency. **READ THIS MANUAL AND THE ONE PROVIDED WITH YOUR TRACTOR AND LOADER.**
- _____ To avoid accident or injury, do not allow anyone to operate this equipment without proper instructions. Any person who operates this equipment must be instructed in and be capable of the safe operation of the power unit, stump grinder and all controls.

OPERATING INSTRUCTIONS (continued)



WARNING

Wear required personal protective equipment. Wear close-fitting clothing and confine long hair. Avoid jewelry, such as rings, wrist watches, necklaces, or bracelets.



WARNING

Keep all spectators and other workers away from the machine and work area while in operation.

Never work on or near the cutter wheel unless the engine is shut off and the cutter wheel stopped.

OPERATION

Observe all operating and safety instructions in this manual and those on the Stump Grinder before using this machine.

1. The relief valve controls the rate of swing as you grind a stump. Make adjustments with the hydraulic system and power unit OFF. To increase the rate of swing (faster), remove the hex cap and using a 5/16" Allen wrench, turn the screw clockwise into the valve body, then reinstall the hex cap. Increase or decrease (turn the screw) about (1) turn at a time until a satisfactory swing rate is obtained to match the available power.
2. Position the tractor for grinding a stump. The 3 pt. frame should be lowered to the ground before grinding the stump. Three point hitch lift arm stabilizer bars, sway chains or sway blocks must be used to control side movement of the stump grinder.
3. **NOTE:** Be sure parking stand is fully raised and fastened with a locking pin before using the stump grinder.
4. Set the tractor brakes or place the transmission in "PARK." Raise the cutting wheel and have it positioned to the left side of the stump and all the way to the left side of the machine.

Right-hand or left-hand reference is determined by standing at the rear of the stump grinder and facing in the forward direction of travel of the power unit.

5. When engaging and disengaging the PTO, the engine speed should always be low. Once the PTO is engaged

and ready to start cutting, raise the PTO speed to 540 RPM and maintain throughout stump cutting operation. **ALWAYS** operate the PTO at 540 RPM. This is necessary to maintain proper wheel speed to obtain a clean, smooth cut. Do not disengage PTO when the engine is at full PTO RPM. Always bring the tractor engine to idle speed before disengaging the PTO.

NOTE: To avoid damage to the clutch, the cutter wheel should not be in contact with the stump when engaging the PTO.



WARNING

Before moving the machine into position, remove loose chunks of wood, stones, wire, and other debris from the stump and work area that might be thrown, causing injury or damage.



WARNING

When cutting a stump, the operator must wear eye protection and must stay on the power unit seat.

6. Position the cutter wheel as shown in figure 7. Start the wheel on the left edge of the stump and engage the side hydraulic cylinder to make a light cut across the stump.
7. When the first cutting pass is complete, raise the cutting wheel slightly with the depth control cylinder and then activate the side control cylinder to move the wheel back to the start position.

Lower the cutter wheel and make a deeper cut. Repeat the previous steps until you have cut approximately 12 inches (30 cm) of the stump.

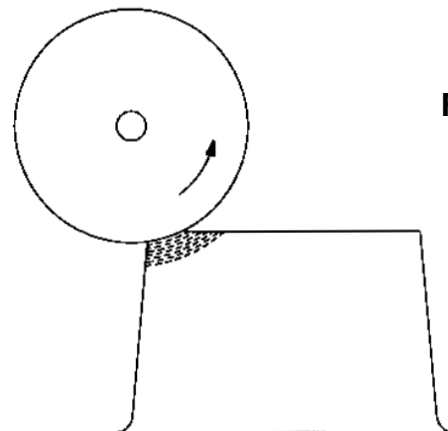

Figure 7

OPERATING INSTRUCTIONS (continued)

OPERATION (continued)

8. If the stump is large, raise the cutter wheel, slow the tractor engine rpm, raise the 3 pt. hitch slightly (so unit foot is off the ground) and move the stump grinder 6" to 8" (15 to 20 cm) further into the stump. Lower the 3 pt hitch, raise the tractor PTO rpm, and repeat previous cutting procedures. (See figure 8).

NOTE: Failure to raise the cutter wheel each time the stump grinder wheel is returned to the "start" position will increase the rate that the cutting teeth become dull.

This increased wear is more pronounced when grinding stumps below ground level in sandy or rocky (abrasive) soil conditions.

9. When cutting a stump, if sparks from the cutting wheel are observed, stop the cutting operation, shut the tractor engine off and investigate.

Sometimes trees will grow around stones or other objects. If this is the situation, remove the foreign object if possible. If it is a steel object, this must be removed as it will break the carbide cutting teeth and/or wheel. Soft sedimentary rocks may be ground with the stump grinder, but they will dull the cutting teeth.

10. If the accumulation of chips interferes with the visibility of the stump, stop the stump grinder, follow normal safe shutdown procedure, and clear the chips away with a rake or shovel.



DANGER

Contact with rotating cutter wheel can kill or dismember. Stop cutter wheel and shut off engine before working near cutter wheel or PTO driveline.

HOW TO CUT STUMPS

Operate the cutting wheel at 540 rpm (speed while under no load). The cutting wheel feed is controlled by the 2" x 24" hydraulic cylinder and the pressure control valve. The rate of cut will depend on the type of tree, condition of the wood, and the condition of the carbide cutting teeth. Excessive feed rates will either stall the engine or slip the clutch. Too light a feed will produce sawdust.

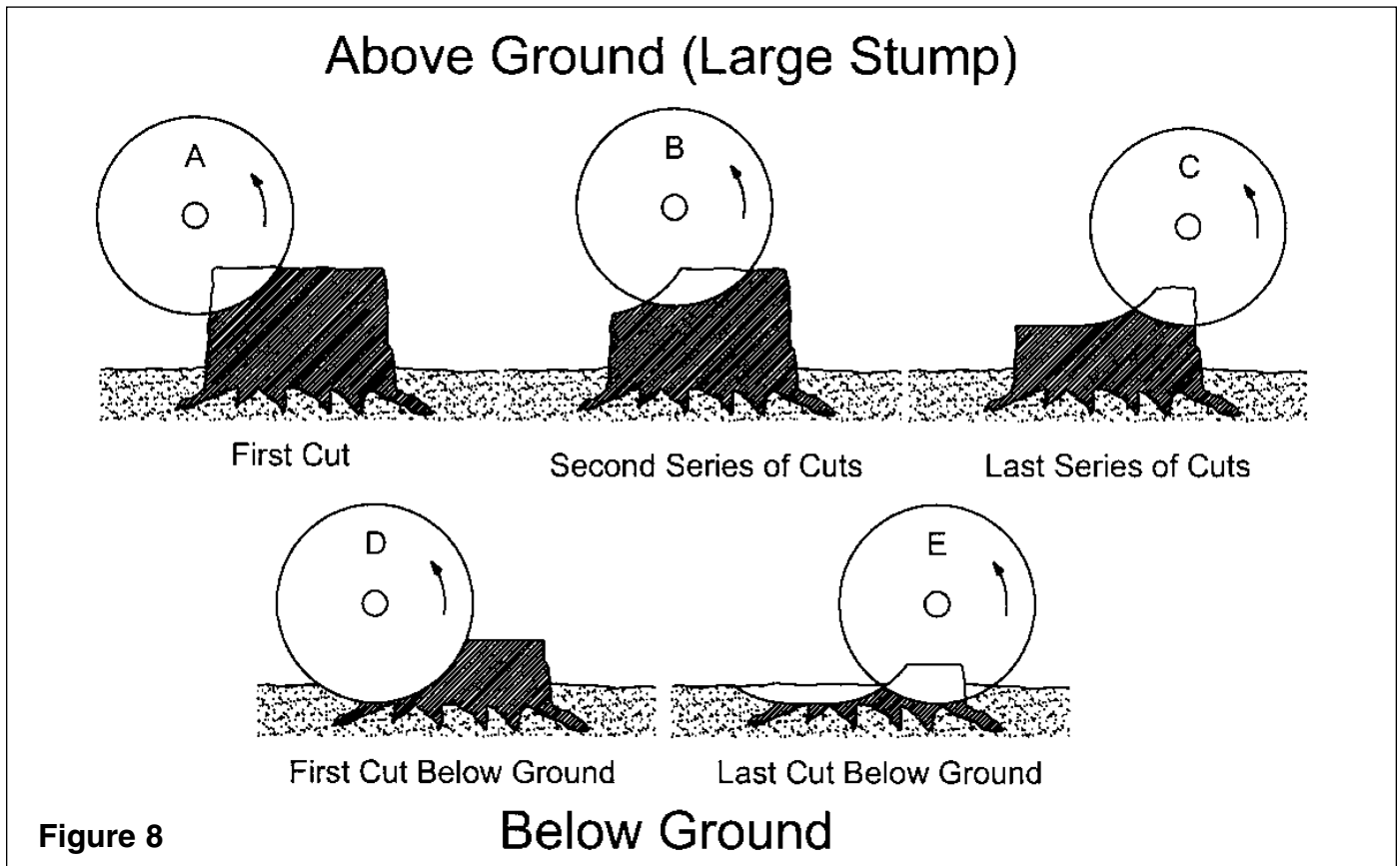

Figure 8

Below Ground

OPERATING INSTRUCTIONS (continued)

OPERATING TIPS

Different types of stumps (tree variety) will cut differently. (i.e. – a Pine stump will cut different than an Oak stump.) Older stumps where the tree was cut several years ago will have “soft” and “hard” areas as the cutting wheel passes across the stump.

Therefore, when grinding a stump, some stumps will cut faster and easier than others.

Remember, sharp teeth produce cleaner cuts and require less power.

If a stump is a few inches taller than 18 inches, you may be able to adjust (shorten) your toplink to accommodate this stump. It is recommended and easier to use a chain saw to cut the stump to a height of 18 inches or less.

If for some reason, you need to grind a stump to a greater below ground depth, you can adjust (lengthen) your toplink to achieve the desired depth.

Remember, carbide teeth are expensive. The less soil contact you have with the cutting wheel will result in the teeth remaining sharp for a longer period of time. Cutting teeth are not a warranty item.

Trees with foreign objects – trees will grow around rocks, iron spikes, horseshoes, wire and other things that are in the ground or put in or against a young growing tree.

Trees that are near where buildings or fence rows are or have been are highly suspect. Always examine these stumps carefully and when grinding, pay close attention to the grinding operation.

Contact with imbedded foreign objects will produce sparks or a different sound.

If you find a foreign object in a stump that you are grinding, try to remove it. Sedimentary stones or rocks can usually be pried out or smashed with an iron bar and hammer. Nails and steel objects need to be removed. It will take time and effort, but you can save yourself a new set of carbide cutting teeth.

Raise the cutting wheel before returning to the “START” position. When you have finished a “cutting pass” raise the cutting wheel slightly before returning to the start position. Failure to do this will dull the teeth. (This is the same as why you always raise a file or hand hacksaw when making your return stroke – dragging the cutting teeth back over the work piece will dull the teeth).

There are three (3) cutting teeth on the backside of the cutting wheel to protect the wheel those few times that you forget to raise it. However, they are not meant to be primary cutters and should not be treated as such.

EXTENDING USEFUL LIFE OF CUTTING TEETH

As the cutting teeth become dull they generally perform better grinding softer woods. When grinding a large number of stumps it is recommended that the hardwood stumps be cut first when the cutting teeth are their sharpest. Then proceed to the soft wood stumps. When this method is combined with recommended teeth rotation on the wheel, maximum tooth life is achieved.

STUMP CUTTING

UP TO 12 INCH DIAMETER STUMPS

These stumps can usually be cut with one tractor position. Position the stump cutting wheel about centered to the stump but to the side. Make the cutting passes necessary to grind the stump down to the desired depth.

STUMPS GREATER THAN 12 INCH DIAMETER

On larger stumps, it will usually require repositioning the power unit a few times.

Always start cutting the side of the stump facing the tractor, when this part is cut down 10-12 inches from the top of the stump, move toward the stump 8-10 inches and repeat the process. If there is still a portion of the stump at near original height, move again toward the stump and repeat the cutting process. (See figure 8.)

If the stump was high or it is desired to cut the stump to a greater depth, then move back to the beginning position and repeat the process.

NOTE: Do not cut stumps so that the cutting wheel leaves an uncut portion of the stump between the cutting wheel and the tractor or skid steer. This portion of the stump can catch the main swing arm of the stump cutter and prevent it from cutting. (See figure 9.)

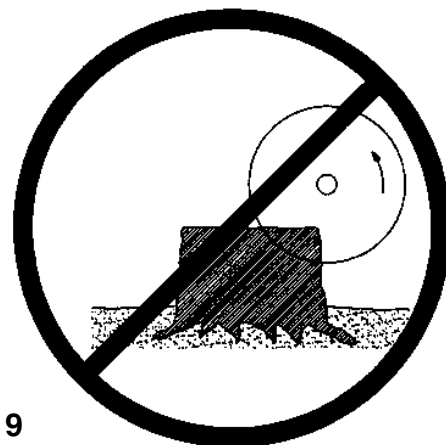

Figure 9

OPERATING INSTRUCTIONS (continued)

CUTTING FEED RATE – PTO MODELS

The cutting feed rate is controlled by the hydraulic pressure relief valve connected to the 2" X 24" hydraulic cylinder. The pressure relief valve is set from the factory at 150 psi. For most tractors and cutting conditions, this should be correct.

If your tractor is on the lower end of the recommended horsepower range of the stump grinder model, it would help if you lowered the pressure setting.

If you are cutting very hard wood and have sufficient tractor horsepower, it could help if you increased the pressure setting.



WARNING

Adjust relief valve only with stump grinder and tractor shut off, then relieve all hydraulic pressure.

Always have the thumb wheel locked securely against the valve body prior to operation. Failure to do so may cause serious personal injury.

TRANSPORTING



CAUTION

When traveling on public roads, whether at night or during the day, use accessory light and devices for adequate warnings to operators of other vehicles. Comply with all federal, state and local laws.

- Pay particular close attention to the Safety Messages regarding cutter transport. Avoid unnecessary injuries and equipment damage by exercising cautious, conscientious travel procedures.
- Be sure to reduce power unit ground speed when turning; and, leave enough clearance so the stump grinder does not contact obstacles such as buildings, trees or fences.
- Select a safe ground travel speed when transporting from one area to another. When traveling on roadways, transport in such a way that faster moving vehicles may pass you safely.
- Allow for additional length of loader and attachment on tractor while turning.
- When traveling over rough or hilly terrain, slow down and use extra care.
- Read all the safety warnings in the front of the manual.
- **DO NOT OPERATE PTO DURING TRANSPORT.**

REMOVING STUMP GRINDER FROM TRACTOR

Properly park tractor, shut off engine, and disengage tractor PTO.

Lower and pin parking stand.

Lower stump grinder with 3 pt. hitch. Lower cutting wheel so parking stand contacts ground.

Shut off power unit engine.

Relieve all hydraulic pressure in hydraulic hose lines.

Disconnect driveline from tractor PTO. Collapse driveline as far as possible and store it to prevent ground contact.

Disconnect hydraulic hoses. Cap hose ends to keep them clean.

Disconnect power unit from stump grinder. Position hydraulic hoses so they are not contacting the ground.

Carefully drive power unit away.

STORING SAFELY

- Make sure stump grinder will be located on a solid surface and in a location away from children, animals, or traffic area.
- Storage location should be level and solid to make hitching and unhitching easy with the grader blade lowered.
- Drain and change the oil in your gearbox.
- Check and replace, where necessary, teeth, bolts, nuts, or bushings, on the machine.
- Replace any safety signs if damaged.
- Sand areas where paint is chipped or worn and repaint to prevent rust. Lubricate all pivot locations on stump grinder to prevent moisture damage during storage.
- Place plastic caps on the hydraulic hose ends.
- Cover the unit to keep it clean.
- Coat hydraulic cylinder rods with lithium based grease.

OWNER SERVICE

The information in this section is written for operators who possess basic mechanical skills. Should you need help, your dealer has trained service technicians available. For your protection, read and follow all safety information in this manual.



WARNING

- ▲ **Before servicing the machine, disengage the PTO, engage the parking brake or place the transmission in “Park,” shut off the power unit and remove the key. Disconnect stump grinder driveline from tractor PTO before performing any service or maintenance.**
- ▲ **Before working underneath, raise 3 pt. hitch to highest position and block stump grinder securely. Hydraulic system leakdown and failure of mechanical or hydraulic system can cause equipment to drop.**
- ▲ **Keep all persons away from operator control area while performing adjustments, service or maintenance.**

ROUTINE MAINTENANCE

DAILY CHECKS:

1. Check that all bolts, nuts, and screws are tight. Checking the bolts and nuts on the cutting wheel is particularly important.
2. Check daily the level of the gearbox oil and top up to the correct level. Check for gearbox oil leaks. It should be noted that no warranty claim can be submitted on a gearbox that has run dry. It is essential that the gearbox is kept correctly filled with gearbox oil.
3. Grease the PTO shaft daily.
4. Check the wear on the cutting teeth. You should keep at least one set of cutting teeth as spares.
5. Check hydraulic hoses. Make sure they are not chafed or pinched. Replace any damaged hose.
6. Check hydraulic hoses and fittings for leaks. Repair any leaks immediately. Never use your hand to check for a hydraulic leak when system is under pressure.
7. Replace any worn or damaged parts immediately. Do not use attachment with any damaged parts.

LUBRICATION INFORMATION

The chart gives the frequency of lubrication in operating hours, based on normal conditions. Severe or unusual conditions may require more frequent lubrication.

Do not let excess grease collect on or around parts, particularly when operating in sandy areas.

Use an SAE 90W gear lube in gearbox.

Use a lithium grease of NO. 2 consistency with a MOLY (molybdenum disulfide) additive for all locations. Be sure to clean fittings thoroughly before attaching grease gun. When applied according to the lubrication chart, one good pump of most guns is sufficient. Do not over grease.

Thoroughly clean the grease zerks before servicing. Dirt mixed with lubricant will rapidly wear parts and destroy bearings. Keep it clean.

LUBRICATION CHART

DESCRIPTION	FREQUENCY
Front U-Joint (PTO)	8 Hrs.
Rear U-Joint (PTO)	8 Hrs.
Gearbox – Fill to proper level	Check Daily
Slip Joint (PTO)	8 Hrs.
Swing Arm Pivot Joint	8 Hrs.

Daily lubrication of the PTO slip joint is necessary. Failure to maintain proper lubrication can result in damage to U-joints, gearbox, tractor PTO and/or stump grinder driveline.

REPLACING CUTTING TEETH

The laminated design of this stump grinder cutting wheel provides a “pocket” for each cutting tooth. This “pocket” design supports each cutting tooth so it can handle the loads encountered in the stump grinding operation.

It is VERY IMPORTANT that when replacing a cutting tooth the empty “pocket” be checked for any possible dirt accumulation. ALWAYS make sure that the “pocket” is CLEAN BEFORE inserting a replacement cutting tooth.

If any dirt is in the “pocket” and the tooth installed, it will not be seated properly and the bolt holding the tooth could come loose. Operating with a loose cutting tooth could result not only in the loss of the tooth, but damage to the “pocket” in the wheel.

When rotating cutting teeth, always clean each tooth before installing it in its “new” pocket location.

OWNER SERVICE (continued)

ROTATING CUTTING TEETH

The cutting teeth on the outer edge and side of the cutting wheel do the majority of the work.

It is recommended that when these teeth become dull, that you exchange them with teeth that are located further towards the center of the wheel. This will spread the wear among the teeth and keep the “sharper” teeth in the main cutting area of the wheel.

The number of stumps that can be ground before replacing teeth depends on several factors:

- a. Any foreign objects contacted?
- b. Abrasive soil conditions.
- c. How deep stumps are cut below ground?
- d. How large are the stumps?
- e. How dry is the soil? (Dry, hard soil will cause more wear than moist soil.)

CUTTING WHEEL & GEARBOX REMOVAL

- A. Raise stump grinder using both the hydraulic lift cylinder and the 3 pt. hitch. Follow normal shutdown procedure before dismounting from the power unit.
- B. Lower the jack stand and pin securely.
- C. Lower the tractor 3 pt. hitch first and then the hydraulic lift cylinder so the stump grinder is on the ground or shop floor. This will position the bottom of the wheel just slightly above ground or floor level.
- D. Remove the side shield from the cutter wheel housing.
- E. Remove the cotter pin and slotted nut. (Use a large block of wood against the edge of the cutting wheel to break the slotted nut loose.)
- F. Use a good three (3) arm wheel puller to pull the cutting wheel off the tapered splined output shaft of the gearbox.

NOTE: Once you have tension on the wheel with the wheel puller, a sharp rap with a hammer will “pop” the wheel off.



WARNING

DO NOT HAVE ANYONE HOLD THE WHEEL WHEN HITTING THE END OF THE PULLER SCREW WITH A HAMMER. The wheel may jump off the shaft and could cause injury!

- G. Screw the slotted nut back on the threads of the gearbox output shaft to keep from losing the nut and to protect the threads on the shaft.
- H. Remove the two bolts holding the PTO clutch assembly on the gearbox input shaft. Slide the PTO clutch assembly off the input shaft.
- I. Remove bolts and locknuts securing gearbox to frame. Remove gearbox.

CUTTING WHEEL & GEARBOX INSTALLATION

- A. Raise stump grinder using both the hydraulic lift cylinder and the 3 pt. hitch. Follow normal shutdown procedure before dismounting from the power unit.
- B. Lower the jack stand and pin securely.
- C. Lower the tractor 3 pt. hitch first and then the hydraulic lift cylinder so the stump grinder is on the ground or shop floor. This will position the bottom of the wheel just slightly above ground or floor level.
- D. Attach gearbox to frame using bolts and nuts.
- E. Install cutting wheel onto gearbox securing with castellated nut and flat washer. Torque nut to 350 ft./lbs. Wear heavy work gloves to protect hands from sharp edges.
- F. Install cotter pin to retain nut. It may be necessary to slightly loosen nut to install cotter pin.
- G. Slide PTO clutch assembly on the the gearbox input shaft. Install the two bolts and tighten.

NOTE: The two bolts need to align with the groove in the gearbox input shaft. It may require moving the PTO clutch assembly forward or back to get proper alignment.

- H. Fill gearbox with oil to proper level.
- I. Replace the side shield on the cutter wheel housing. Tighten these nuts securely.

OWNER SERVICE (continued)

SLIP CLUTCH ADJUSTMENT

The slip clutch is designed to slip, protecting the gearbox and driveline, should the cutting wheel strike an obstruction.

A new slip clutch, or one that has been in storage over the winter, may seize. Before operating, make sure it will slip by performing this operation:

Make sure tractor engine is turned off and key is removed.

Remove driveline from tractor PTO.

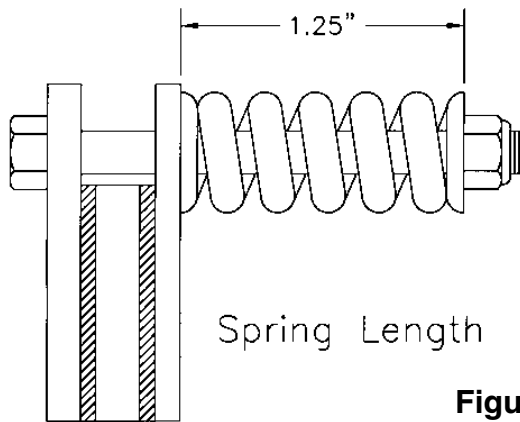

Figure 10

The slip clutch is factory preset to the correct torque for protecting implement and tractor.

Loosen the eight bolts to remove all tension from springs (until spring can be turned with fingers).

Hold clutch hub solid and turn shaft to make sure clutch slips.

If clutch does not slip freely, disassemble and clean the faces of clutch plate, yoke and plate, and clutch hub.

Reassemble clutch.

Tighten each of the eight bolts evenly until the springs are compressed to 1.25" as shown in figure 10. If necessary, adjust nut on any spring that is unequal. Adjust all eight spring retaining nuts 1/3 of a turn (2 flats on a nut) and check clutch slippage. If further adjustment is necessary, do so in 1/3 increments. Adjust only to provide sufficient torque to prevent slippage under normal conditions. Occasional slippage is normal for drivetrain protection. If satisfactory results cannot be obtained, consult your dealer.

If a clutch continues to slip when the springs are compressed to 1.25", check friction disc for excessive wear. Discs are 1/8" when new. Replace discs after 1/16" wear. Minimum disc thickness is 1/16".

FIELD ADJUSTMENT

If necessary, adjust nut on any spring that is unequal. Adjust all eight spring retaining nuts 1/3 of a turn (2 flats on a nut) and check clutch slippage. If further adjustment is necessary, do so in 1/3 turn increments. Adjust only to provide sufficient torque to prevent slippage under normal conditions. Occasional slippage is normal for drivetrain protection. If satisfactory results cannot be obtained, clutch discs and springs may have to be replaced.

NOTE: Constant clutch slipping could be due to field conditions – check Trouble-shooting section in manual.



WARNING

Avoid personal injury! Be sure tractor engine is off, that key is removed from ignition and allow cutting wheel to completely stop turning before dismounting to make adjustments.

**OBEY SAFETY
RULES!!
ALWAYS BE
CAREFUL!!**



**SAFETY ...
YOU CAN LIVE WITH IT!**

TROUBLE-SHOOTING

PROBLEM	POSSIBLE CAUSE	POSSIBLE REMEDY
Stump grinder wheel raises during cut	<ol style="list-style-type: none">1. Dull teeth.2. Foreign object in stump.	<p>Rotate or replace teeth.</p> <p>Check – remove object if possible.</p>
Tractor stalls	<ol style="list-style-type: none">1. Too large of cut.2. Tractor or skid steer too small.3. Tractor PTO rpm too low.4. Too heavy of cut.5. Teeth dull.	<p>Reduce cut depth or reposition power unit so wheel only cuts part of stump.</p> <p>Use larger power unit.</p> <p>Operate at 540 PTO rpm.</p> <p>Only apply interrupted hydraulic pressure to swing cylinder (let tractor recover rpm before applying more side cutting pressure).</p> <p>Replace teeth.</p>
Breaking cutting teeth	<ol style="list-style-type: none">1. Contact with stones or other foreign objects.	<p>Check – remove stones or foreign object.</p> <p>Replace broken teeth.</p>
Stump grinder will not grind stump enough below ground level	<ol style="list-style-type: none">1. Toplink needs adjusting.	<p>Adjust toplink.</p>
Stump grinder will not grind high enough	<ol style="list-style-type: none">1. Toplink needs adjusting.	<p>Adjust toplink.</p>
Stump grinder wheel shows wear	<ol style="list-style-type: none">1. Operating too long with dull teeth.2. Operating below ground level in abrasive soil conditions.3. Operating wheel with teeth missing.4. Contact with foreign objects.	<p>Replace or rotate teeth more often.</p> <p>Do not grind stumps below ground more than necessary.</p> <p>Always operate cutting wheel with full set of cutting teeth. Check wheel often.</p> <p>Be more observant when operating.</p>

TROUBLE-SHOOTING (continued)

PROBLEM	POSSIBLE CAUSE	POSSIBLE REMEDY
Teeth wear too fast	1. Cutting in sandy conditions.	Don't grind below ground more than necessary.
	2. Cutting in rocky conditions.	Remove rocks from around stump.
	3. Operator not raising wheel when returning to "start" position.	Raise wheel slightly before returning to "start" position (see page 24).
	4. Cutting teeth hitting foreign object in stump.	Check stump for wire, iron, spike, horseshoe, etc. Remove.
	5. Operator not rotating teeth.	Rotate teeth.
Stump grinder seems to require excessive power	1. Advancing into stump too rapidly or too great a cut.	Take less cut or reduce hydraulic feed pressure (see page 27).
	2. Worn or dull teeth.	Rotate or replace teeth.
	3. Tractor not large enough.	Use larger tractor.
Stump grinder moves from side to side when cutting	1. Loose tractor sway chains or bars, or sway block improperly installed.	Adjust sway chains, bars, or sway blocks.
	2. Stump grinder not properly latched on skid steer.	Check latches.
Stump grinder will not cut all the time (slip clutch drive)	1. Slip clutch slipping.	Adjust slip clutch according to instructions.
	2. Tractor PTO clutch slipping.	Check tractor PTO – replace clutch if necessary.
	3. Low hydraulic oil.	Check oil level.
	4. Teeth dull and stump is hardwood.	Replace teeth.
	5. See – "Stump grinder will not feed into stump".	

TROUBLE-SHOOTING (continued)

PROBLEM	POSSIBLE CAUSE	POSSIBLE REMEDY
Hydraulic hose failure	1. Power unit hydraulic relief pressure setting is very high and may cause hydraulic hose failure.	Check power unit hydraulic system and adjust relief valve.
	2. Hoses are worn or frayed.	Replace hose.
	3. Hose rating may be too low for hydraulic system pressure.	Replace with higher rated hoses.
	4. Hose is being pinched by movement of 3 pt. mount or 3 pt. linkage.	Reroute hose and refasten.
Hydraulic oil overheats	1. Hydraulic oil level in tractor may be low.	Check and add oil.
	2. Hydraulic oil or oil filter in tractor may be dirty.	Change oil and filter according to power unit manufacturer's recommendations.
	3. Hydraulic oil reservoir of tractor may be small.	Allow time for oil to cool down.
	4. Tractor has closed center hydraulic system.	Flow control should be at minimum flow. If no flow control, add restrictor orifice (throttle valve) to reduce flow (see page 22).
Stump grinder wheel will not feed into stump	1. Too big of a cut.	Raise wheel and take less cut.
	2. Operator cut rear part of stump first. Front uncut part of stump is holding wheel arm.	Raise and reposition stump grinder to cut front part of stump – then go back to rear to cut deeper.
	3. Teeth very dull.	Replace teeth.
	4. Low hydraulic oil in tractor or tractor is on steep hill and oil in reservoir is away from pump inlet.	Check oil level. Reposition tractor in other direction (if possible).
	5. Quick couplers on swing cylinder hoses not properly engaged (or wrong couplers for tractor remote hydraulic outlets).	Check couplers and make sure they are connected properly.
	6. Relief valve setting too low.	Check and increase relief valve pressure. (Best if checked with pressure gauge.)

TROUBLE-SHOOTING (continued)

PROBLEM	POSSIBLE CAUSE	POSSIBLE REMEDY
Gearbox noisy	1. Rough gears.	Run in or change gears.
	2. Worn bearings.	Replace bearing.
	3. Low oil in gearbox.	Check level and add oil.
Gearbox leaking	1. Damaged oil seal.	Replace seal.
	2. Bent shaft.	Replace oil seal and shaft.
	3. Shaft rough in oil seal area.	Replace or repair shaft.
	4. Oil seal installed wrong.	Replace seal.
	5. Oil seal not sealing in the housing.	Replace seal or use a sealant on outside diameter of seal.
	6. Oil level too high.	Drain oil to proper level.
	7. Hole in gearbox.	Replace gearbox.
	8. Gasket damaged.	Replace gasket.
	9. Bolts loose.	Tighten bolts.
Gearbox overheating	1. Low on lubricant.	Fill to proper level.
	2. Improper type lubricant.	Replace with proper lubricant.
	3. Excessive trash build-up around gearbox.	Remove trash.
Excessive vibration	1. Check gearbox bolts.	Tighten if loose.
	2. Check for loose nut and cutting wheel.	Tighten if loose.
	3. Check for bent output shaft. If shaft is bent, oil will normally leak from output seal.	Replace shaft if bent.
	4. Drivelines not phased correctly. Implement and tractor yokes must be in line.	Replace driveline.
	5. Wire or rope wrapped around cutting wheel.	Remove wire or rope.
	6. Teeth worn.	Replace teeth.
	7. Teeth missing on wheel.	Check and replace teeth.
	8. Too heavy cut.	Reduce cutting depth or reduce hydraulic feed pressure.

SG-26A/SG-36A STUMP GRINDER HYDRAULIC DIAGRAM & PARTS LIST

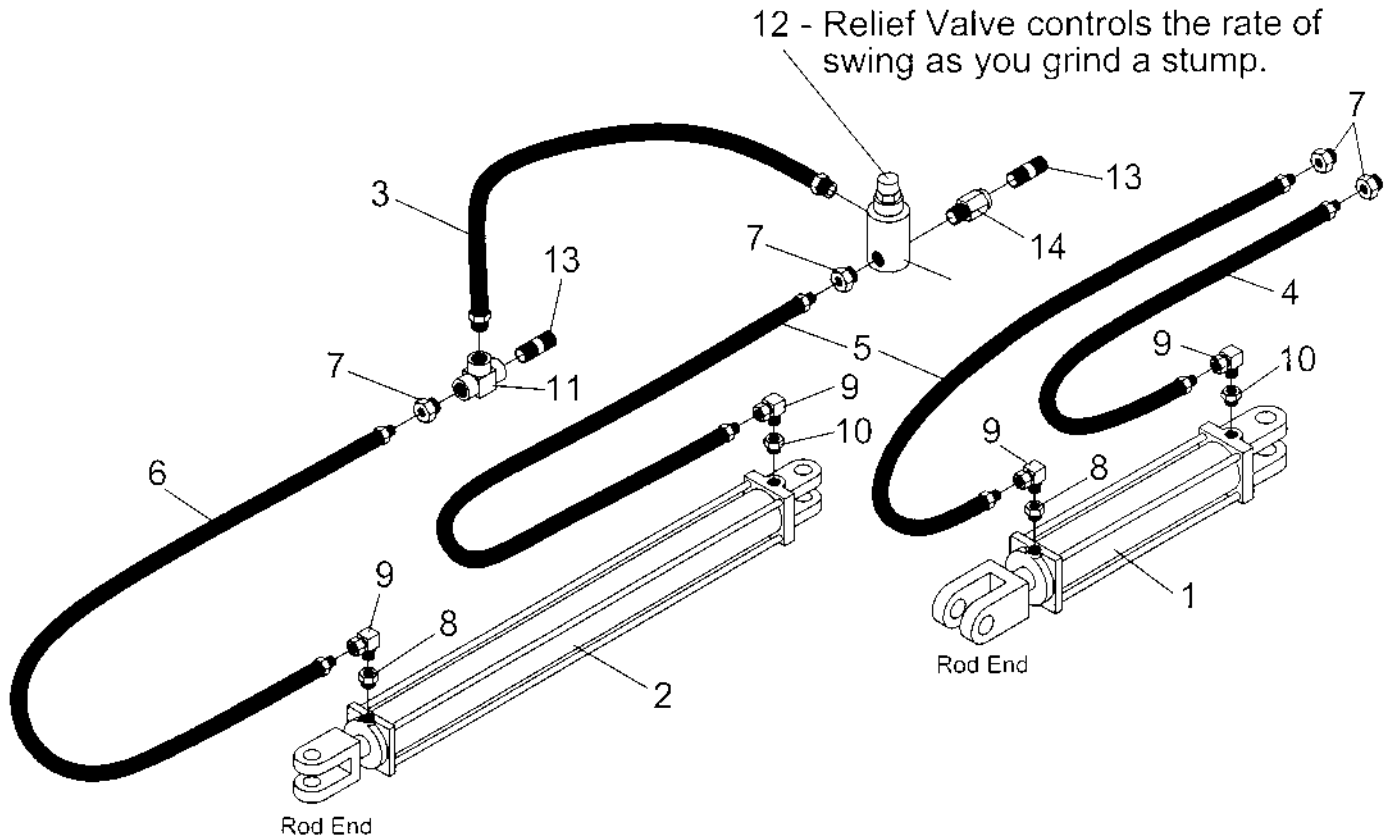

Ref. No.	Part No.	Description	No. Req'd.
1	2504215	Hydraulic Cylinder 2 1/2" x 10"	1
2	2504120	Hydraulic Cylinder 2" x 24"	1
3	2505630	Hose, Hydraulic 1/2" ID x 12"	1
4	2505532	Hose, Hydraulic 1/4" ID x 60"	1
5	2505533	Hose, Hydraulic 1/4" ID x 72"	2
6	2505537	Hose, Hydraulic 1/4" ID x 96"	1
7	2505507	Bushing, Reducer 1/2" to 1/4"	4
8	2505626	Bushing, Reducer 3/8" to 1/4" w/ .040" Orifice	2
9	2505530	Elbow, 90° Swivel 1/4"-18NPT	4
10	2505517	Bushing, Reducer 3/8" to 1/4"	2
11	2505553	Tee, Hydraulic 1/2"NPT	1
12	2505641	Valve, Relief (Low Pressure)	1
13	2505512	Pipe Nipple 1/2" x 2"	2
14	2505642	(Optional) Throttle Valve (For Closed Center Hyd. Systems)	1

SG-26A STUMP GRINDER PARTS DRAWING

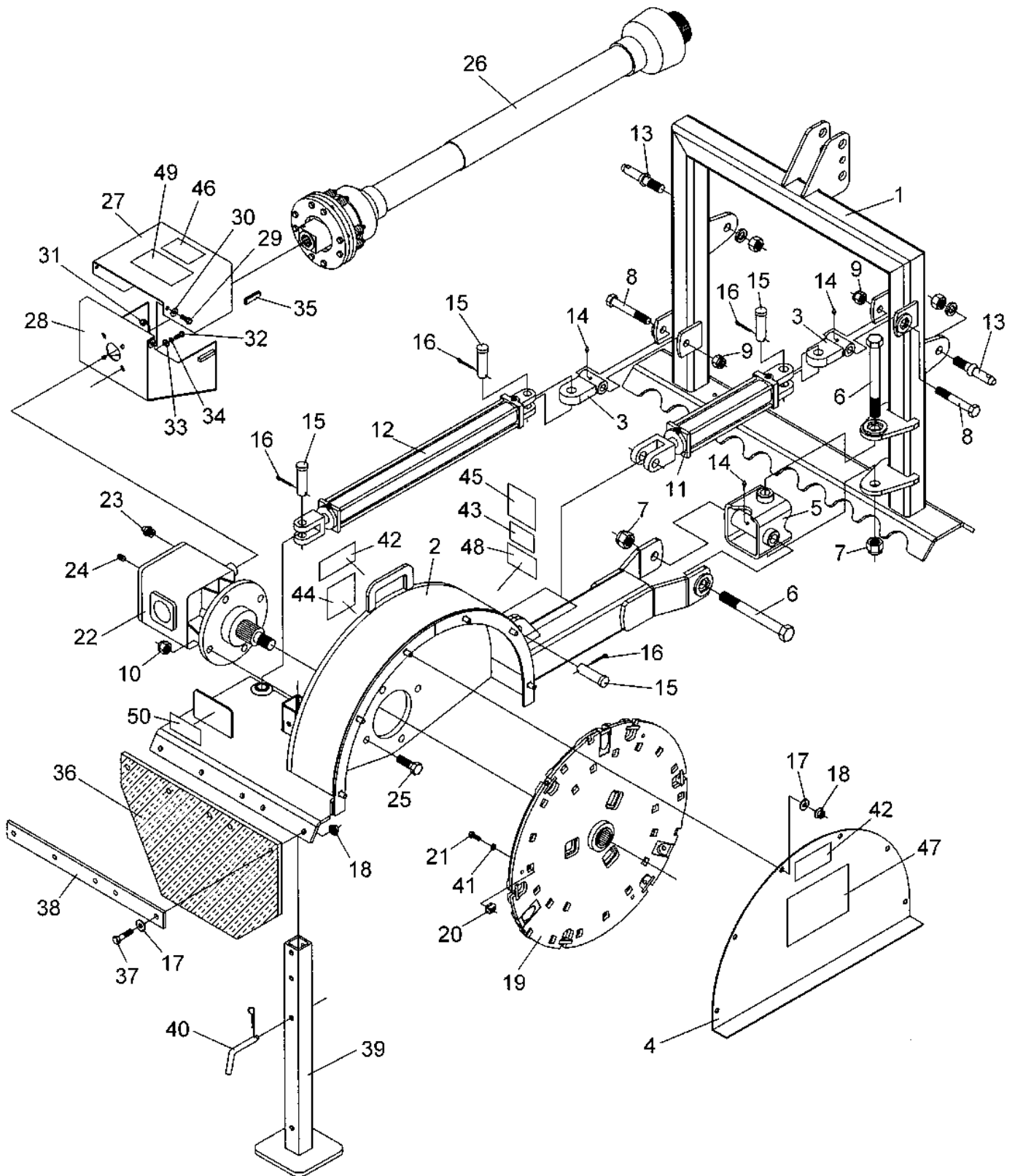

SG-26A STUMP GRINDER PARTS LIST

Ref. No.	Part No.	Description	No. Req'd.
1	812201	3 Pt. Yoke Weldment	1
2	812211	Housing Weldment	1
3	812225	Cylinder Pivot Lug	2
4	811510	Wheel Guard Weldment	1
5	812220	Cross Weldment (Knuckle)	1
6	2503236	Bolt 1"-8NC x 9" Hex Head Gr.5	2
7	2500045	Nut 1"-8NC Hex Nylock	2
8	2503087	Bolt 3/4"-10NC x 5" Hex Head Gr.5	2
9	2500037	Nut 3/4"-10NC Hex Nylock	2
10	2500084	Nut 3/4"-10NC Vibration Proof	4
11	2504265	Hydraulic Cylinder 2 1/2 x 10	1
12	2504263	Hydraulic Cylinder 2 x 24	1
13	590108	Draw Pin (AK-578)	2
14	2504049	Drive Zerk 5/16"	4
15	863070	Cylinder Pin Ø1"	4
16	2504121	Cotter Pin 3/16" x 1 1/2"	4
17	2501003	Washer 1/2" Flat	11
18	2500040	Nut 1/2"-13NC Whiz Flange Hex	11
19	811531	Grinder Wheel Weldment (SG-26)	1
20	811534	Carbide Tooth	33
21	2503061	Bolt 3/8"-16NC x 1" Hex Head Gr.8	33
22	811567	Gearbox Assembly w/Plugs	1
23	2504072	Breather Plug 1/2"NPT	1
24	2504222	Pipe Plug 1/4"NPT Square Head	1
25	2503258	Bolt 3/4"-10NC x 2 1/4" Hex Head Gr.5	4
26	650475	PTO Assembly	1
27	811540	Lid, Shield	1
28	811520	PTO Shield Weldment	1
29	2503011	Bolt 3/8"-16NC x 1" Hex Head Gr.2	2
30	2501004	Washer 3/8" Flat	2
31	2500042	Nut 3/8"-16NC Hex Nylock	2
32	2503304	Bolt M8 x 16mm Hex Head	4
33	2501012	Washer 5/16" Flat	4
34	2502011	Washer 5/16" Springlock	4
35	811559	Edging Strip 2"	2
36	811541	Rubber Guard	1
37	2503007	Bolt 1/2"-13NC x 2" Hex Head Gr.2	5
38	811547	Guard Retainer Strap	1
39	811557	Stand Weldment	1
40	343180	Hitch Pin 1/2" x 3" w/Clip	1
41	2502008	Washer 3/8" Springlock	33
42	101027	Safety Sign-Warning (Stand Clear)	2
43	101101	Safety Sign-Warning (540 RPM)	1
44	101103	Safety Sign-Danger (Keep Away)	1
45	101122	Safety Sign-Warning (Hi-Pressure)	1
46	101186	Safety Sign-Warning (Shields)	1
47	101206	Safety Sign-Danger (Debris)	1
48	101219	Safety Sign-Warning (Valve)	1
49	101201	Safety Sign-Warning (Manual)	1
50	101209	Safety Sign-Red Reflector	1

* NOTE: Order 811600 for repair kit containing (12) twelve carbide teeth, bolts & washers

SG-36A STUMP GRINDER PARTS DRAWING

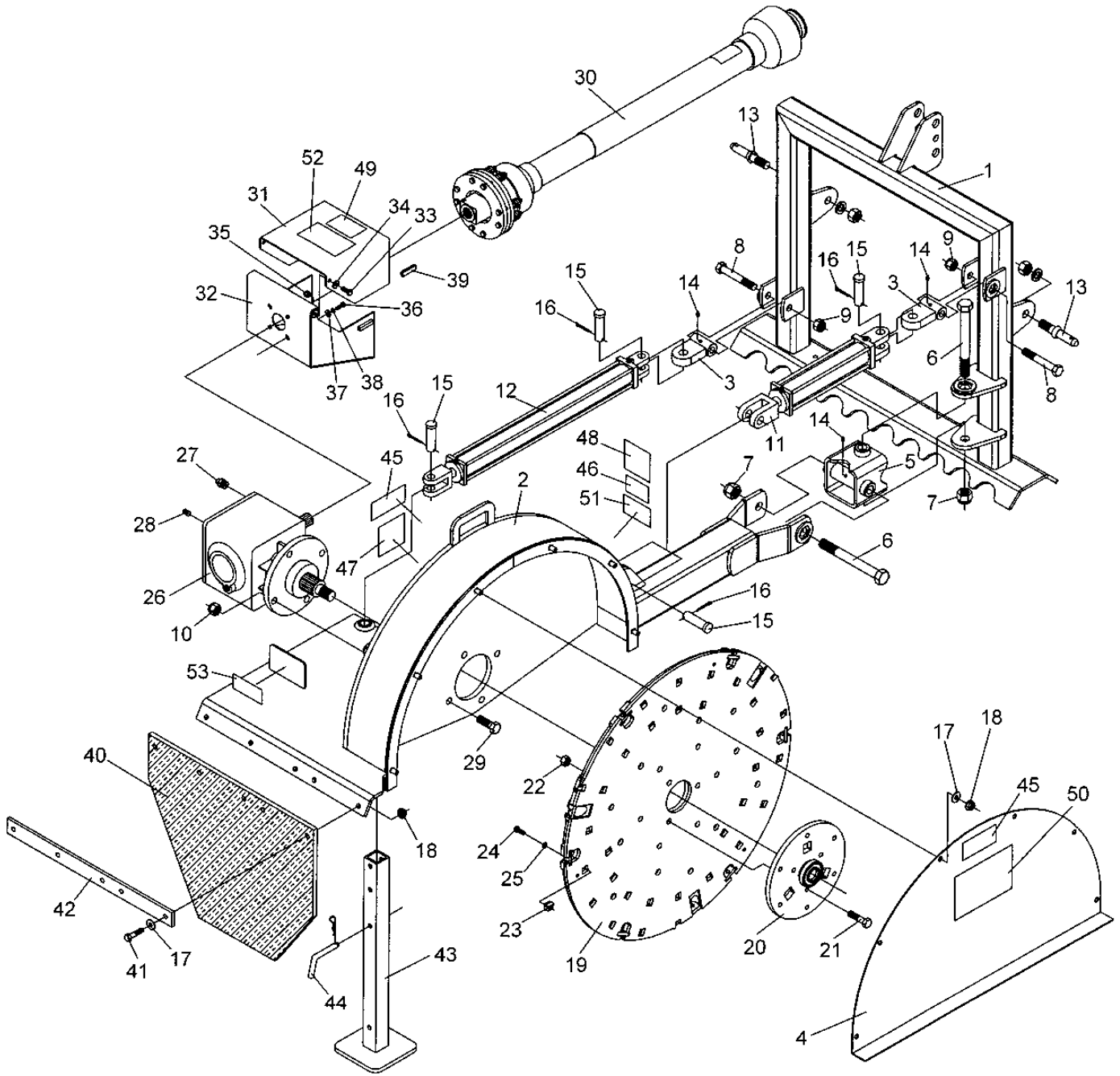

SG-36A STUMP GRINDER PARTS LIST

Ref. No.	Part No.	Description	No. Req'd.
1	812201	3 Pt. Yoke Weldment	1
2	812216	Housing Weldment	1
3	812225	Cylinder Pivot Lug	2
4	811560	Wheel Guard Weldment	1
5	812220	Cross Weldment (Knuckle)	1
6	2503236	Bolt 1"-8NC x 9" Hex Head Gr.5	2
7	2500045	Nut 1"-8NC Hex Nylock	2
8	2503087	Bolt 3/4"-10NC x 5" Hex Head Gr.5	2
9	2500037	Nut 3/4"-10NC Hex Nylock	2
10	2500084	Nut 3/4"-10NC Vibration Proof	4
11	2504265	Hydraulic Cylinder 2 1/2 x 10	1
12	2504263	Hydraulic Cylinder 2 x 24	1
13	590078	Draw Pin (AK-2118)	2
14	2504049	Drive Zerk 5/16"	4
15	863070	Cylinder Pin Ø1"	4
16	2504121	Cotter Pin 3/16" x 1 1/2"	4
17	2501003	Washer 1/2" Flat	11
18	2500040	Nut 1/2"-13NC Whiz Flange Hex	11
19	811616	Grinder Wheel Weldment (SG-36)	1
20	811610	Hub Weldment	1
21	2503088	Bolt 5/8"-11NC x 2 1/2" Hex Head Gr.5	9
22	2500083	Nut 5/8"-11NC Vibration Proof	9
23	811534	Carbide Tooth	42
24	2503061	Bolt 3/8"-16NC x 1" Hex Head Gr.8	42
25	2502008	Washer 3/8" Springlock	42
26	811572	Gearbox Assembly w/Plugs	1
27	2504072	Breather Plug 1/2"NPT	1
28	2504222	Pipe Plug 1/4"NPT Square Head	1
29	2503085	Bolt 3/4"-10NC x 2 1/2" Hex Head Gr.5	4
30	650280	PTO Assembly	1
31	811540	Lid, Shield	1
32	811520	PTO Shield Weldment	1
33	2503011	Bolt 3/8"-16NC x 1" Hex Head Gr.2	2
34	2501004	Washer 3/8" Flat	2
35	2500042	Nut 3/8"-16NC Hex Nylock	2
36	2503304	Bolt M8 x 16mm Hex Head	4
37	2501012	Washer 5/16" Flat	4
38	2502011	Washer 5/16" Springlock	4
39	811559	Edging Strip 2"	2
40	811571	Rubber Guard	1
41	2503007	Bolt 1/2"-13NC x 2" Hex Head Gr.2	5
42	811548	Guard Retainer Strap	1
43	811557	Stand Weldment	1
44	343180	Hitch Pin 1/2" x 3" w/Clip	1
45	101027	Safety Sign-Warning (Stand Clear)	2
46	101101	Safety Sign-Warning (540 RPM)	1
47	101103	Safety Sign-Danger (Keep Away)	1
48	101122	Safety Sign-Warning (Hi-Pressure)	1
49	101186	Safety Sign-Warning (Shields)	1
50	101206	Safety Sign-Danger (Debris)	1
51	101219	Safety Sign-Warning (Valve)	1
52	101201	Safety Sign-Warning (Manual)	1
53	101209	Safety Sign-Red Reflector	1

* NOTE: Order 811600 for repair kit containing (12) twelve carbide teeth, bolts & washers

SG-26A GEARBOX PARTS DRAWING & LIST

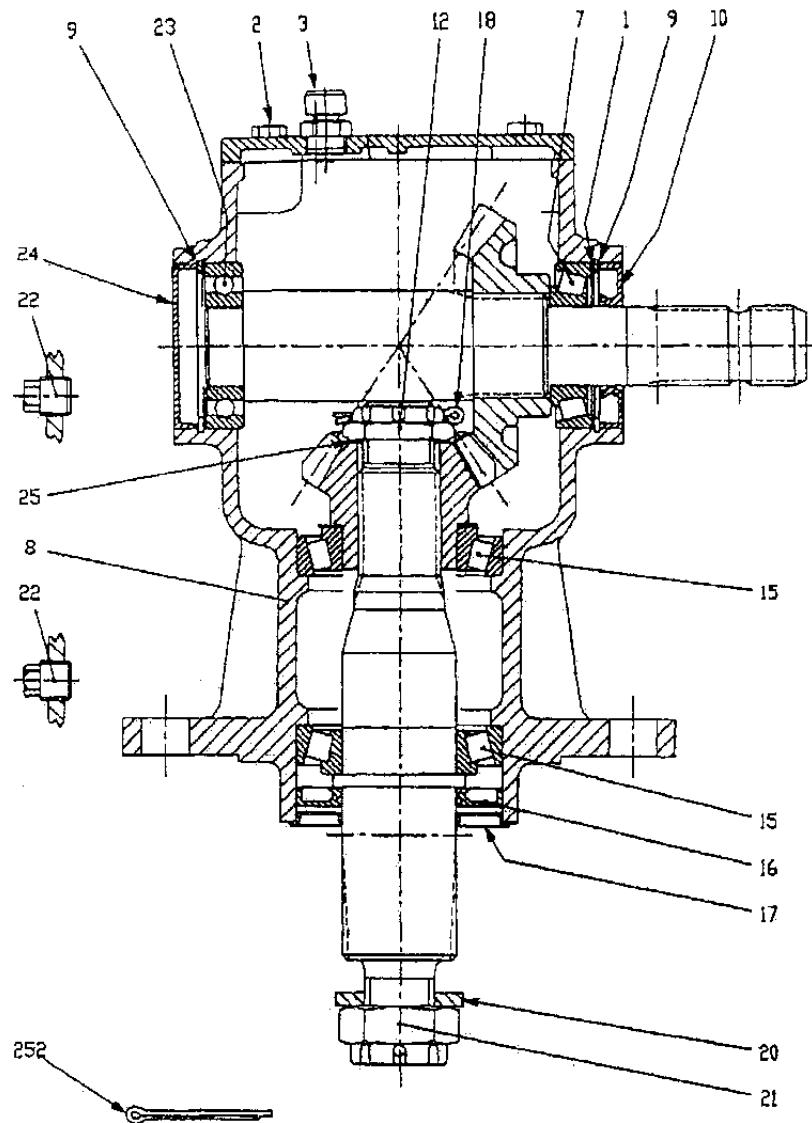

Ref. No.	Worksaver Part No.	Comer Part No.	Description	No. Req'd.
1	811567		Complete Gearbox	1
2	650481	8.1.1.00041	Bolt M8 x 22 HH (8.8)	4
3	2504072	8.6.7.00269	1/2" Oil Filler Vent Plug	1
7	650281	8.0.9.00026	Roller Bearing 30207 (35 x 72 x 18.25)	1
9	650264	8.5.2.00131	Snap Ring (72 x 75 x 2.5)	2
10	650282	8.7.3.00055	Oil Seal (35 x 72 x 10)	1
12	650484	0.132.7106.00	Castle Nut M30 x 1.5	1
15	650423	8.0.9.00469	Roller Bearing 30210 (50 x 90 x 21.75)	2
16	650289	8.7.1.01107	Oil Seal (50 x 90 x 10)	1
17	650288	0.139.7100.00	Protective Washer	1
18	650489	8.4.7.01111	Cotter Pin B4 x 50	1
20	650286	0.139.7101.00	Flat Washer (31 x 56 x 6)	1
21	650287	0.140.7102.00	Castle Nut M30 x 2 (8.8)	1
22	709052	8.6.5.00006	3/8" Solid Plug	2
23	171017	8.0.1.00870	Ball Bearing 6207 (35 x 72 x 17)	1
24	650263	8.7.0.00744	Oil Cap (Ø72 x 10)	1
25	650291	0.102.7510.00	Shim Kit (30.3 x 44 x 1)	1
252	650482	8.4.7.00146	Cotter Pin - Uni 1336 B6 x 60	1
NS	2504222		Pipe Plug 1/4" NPT Square Head	1

SG-36A GEARBOX PARTS DRAWING & LIST

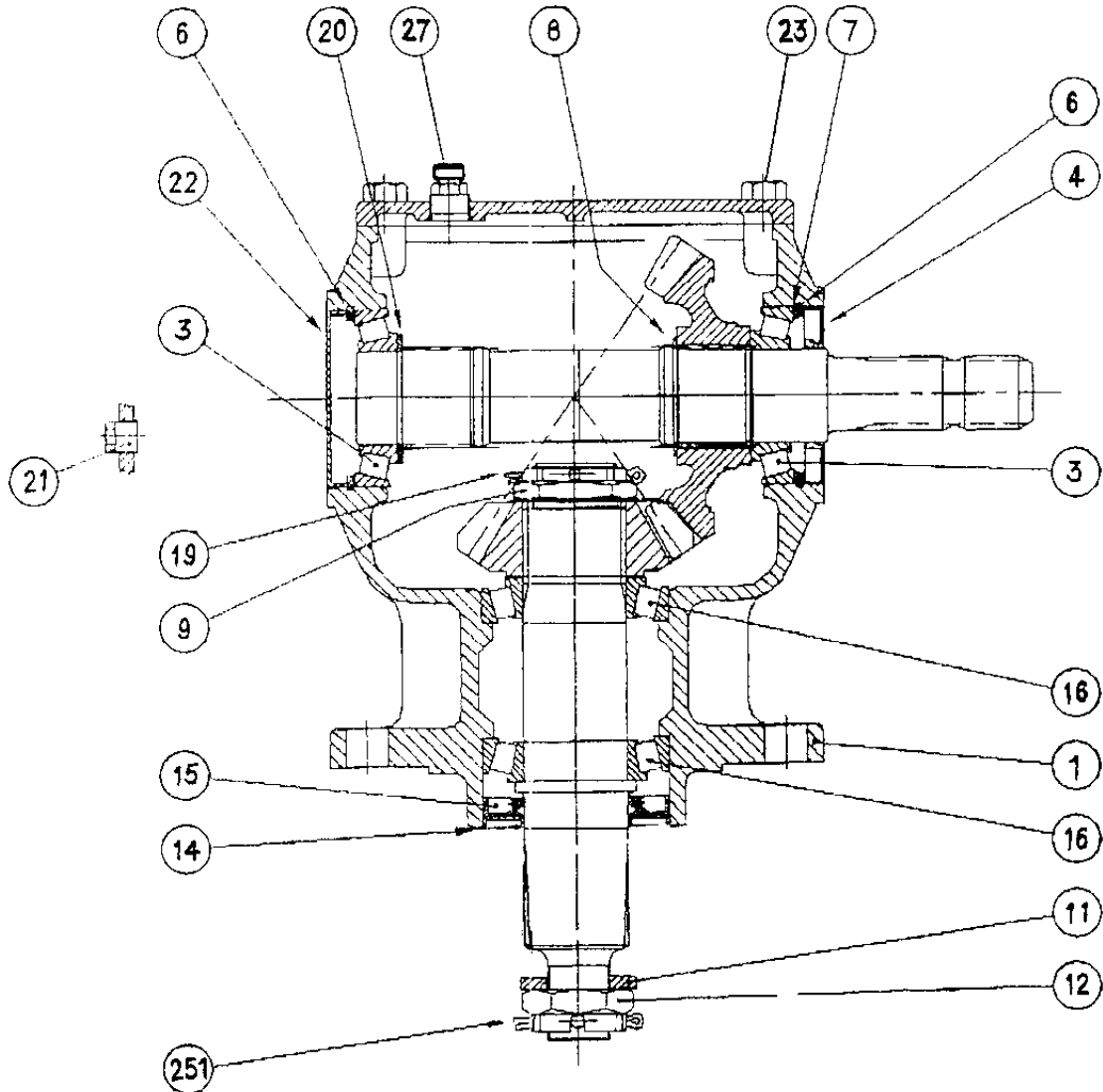

Ref. No.	Worksaver Part No.	Comer Part No.	Description	No. Req'd.
1	811572		Complete Gearbox	1
3	811580	8.0.9.00143	Bearing 30209 (45 x 85 x 20.75)	2
4	811581	8.7.3.00331	Oil Seal (45 x 85 x 10)	1
6	811582	8.5.2.00332	Snap Ring (85 x 88.5 x 3)	2
8	811584	8.5.1.00533	Snap Ring (50 x 47 x 2)	1
9	811585	0.132.7107.00	Castle Nut M40 x 1.5	1
11	650286	0.139.7101.00	Flat Washer (31 x 56 x 6)	1
12	650434	8.2.2.00555	Castle Nut M30 x 2	1
14	650288	0.139.7100.00	Protective Washer	1
15	650289	8.7.1.01107	Oil Seal (50 x 90 x 10)	1
16	650423	8.0.9.00469	Roller Bearing 30210 (50 x 90 x 21.75)	2
19	811587	8.4.7.02265	Cotter Pin B5 x 60	1
20	811588	0.252.7525.00	Shim (45.3 x 65.3 x 2.5)	1
21	709052	8.6.5.00006	3/8" Solid Plug	1
22	811589	0.121.7101.00	Oil Cap (85 x 10)	1
23	811590	8.1.1.00031	Bolt M8 x 25 HHB (8.8)	4
27	2504072	8.6.7.00269	1/2" Oil Filler Vent Plug	1
251	650482	8.4.7.00146	Cotter Pin - Uni 1336 B6 x 60	1
NS	2504222		Pipe Plug 1/4" NPT Square Head	1

SG-26A PTO SHAFT PARTS DRAWING & LIST

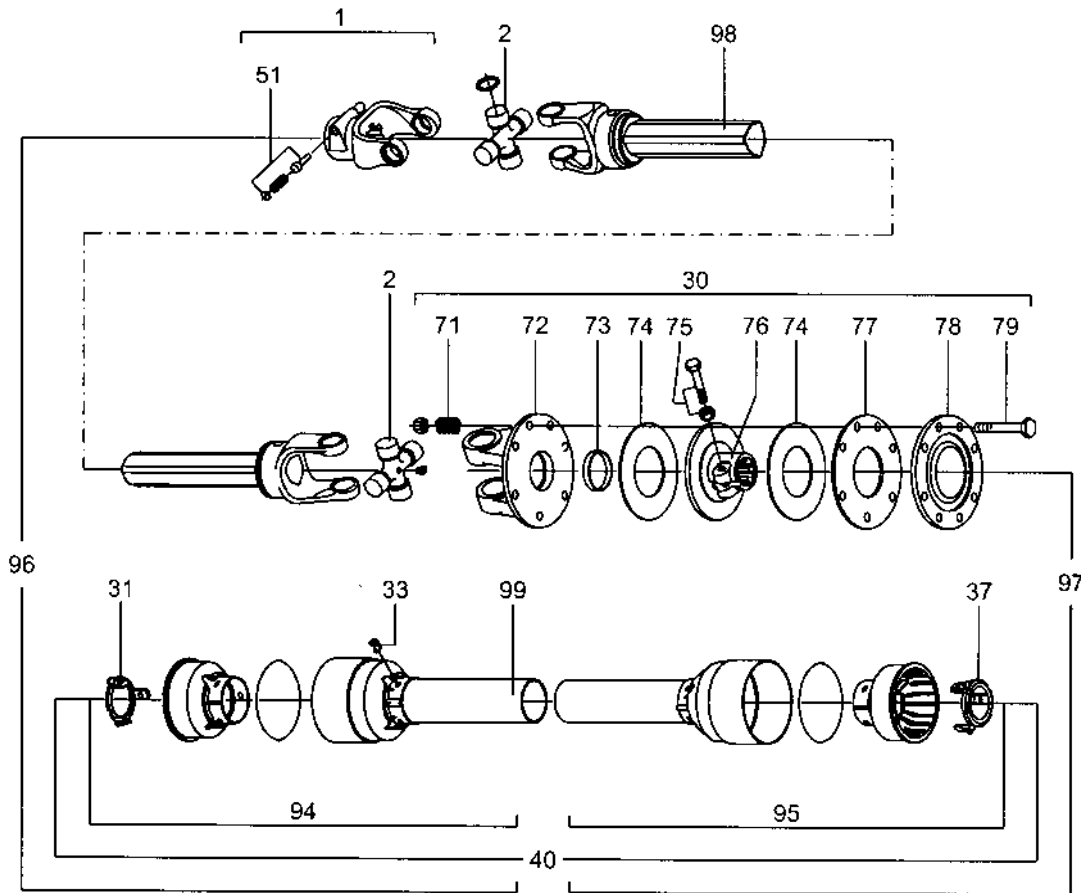

Ref. No.	Worksaver Part No.	Ref. No. (E & G)	Description	No. Req'd.
	650475	07.582.024.10	Complete Driveline Assembly	1
1	650701	141.025.001	Push Pin Yoke 112	1
2	650702	180.015.130	Cross Journal Set	2
30	650740	146.252.011	Complete Disc Clutch	1
31	650710	180.015.009	Guard Retaining Collar for Outer Tube	1
33	650712	190.000.019	Bolt, Plastic Retainer	6
37	650716	180.015.008	Guard Retaining Collar for Inner Tube	1
40	650763	142.250.007.7520	Complete Guard	1
51	650719	166.026.004	Push Pin Set 1 3/8"	1
71	650745	180.019.017	Spring	8
72			Flanged Yoke (See Ref. #76, 77, 78)	1
73	650747	180.019.019	Bushing	1
74	650748	180.019.018	Lining Ring	2
75	650749	165.000.502	Bolt M12 x 1.25 x 65 w/Nut	2
76			Clutch Support	} Only Available as Ref. #30 650740
77			Inner Plate	
78			Pressure Plate	
79	650753	165.000.549	Bolt M10 x 85 w/Nut	8
94	650764	142.251.170.7520	Half Female Guard	1
95	650765	142.251.247.7521	Half Male Guard	1
96	650766	123.250.708.10	Only Available as	1
97	650767	123.250.398.10	Complete Driveline #650475	1
98	650726	190.000.098	"DANGER" Label for Outer Tube	1
99	650727	190.000.099	"DANGER" Label for Outer Guard Tube	1

SG-36A PTO SHAFT PARTS DRAWING & LIST

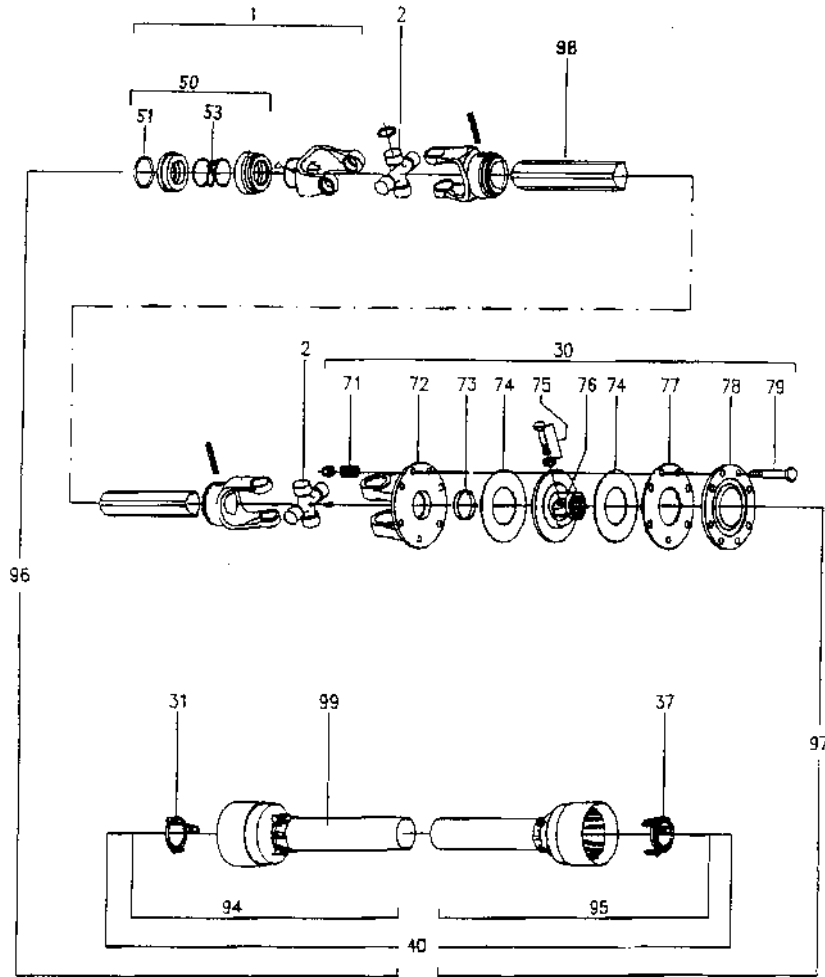

Ref. No.	Worksaver Part No.	Comer Part No.	Description	No. Req'd.
	650280	07.682.088.10	Complete Driveline Assembly	1
1	650292	141.026.544	Complete Collar Yoke C12	1
2	650293	180.016.130	Cross Journal Set	2
30	650294	146.262.011	Complete Disc Clutch F22	1
31	650295	180.016.016	Guard Retaining Collar for Outer Tube	1
37	650296	180.016.015	Guard Retaining Collar for Inner Tube	1
40	650297	142.260.051.7620	Complete Guard	1
50	650298		Slide Lock Collar Repair Kit	1
51	650299	190.000.451	Outer Circlip	1
53	650314	180.016.487	Spring, Collar	1
71	650745	180.019.017	Spring, Disc Clutch	8
72			Flanged Yoke (See Ref. #76, 77, 78)	1
73	650747	180.019.019	Bushing	1
74	650748	180.019.018	Lining Ring	2
75	650749	165.000.502	Bolt M12 x 1.25 x 65 w/Nut	1
76			Clutch Support F22	1
77			Inner Plate	1
78			Pressure Plate	1
			} Only Available as Ref. #30	
			} 650294	
79	650753	165.000.549	Bolt M10 x 85 w/Nut	8
94	650318	142.261.033.7620	Half Female Guard	1
95	650319	142.261.334.7620	Half Male Guard	1
96	650328	123.360.226.10	Only Available as	1
97	650329	123.460.286.10	Complete Driveline #650280	1
98	650726	190.000.098	"DANGER" Label for Outer Tube	1
99	650727	190.000.099	"DANGER" Label for Outer Guard Tube	1

SAFETY REQUIREMENTS

AVOID ACCIDENTS BY FOLLOWING ALL OF THE SAFETY REQUIREMENTS LISTED BELOW.

- Machinery should be operated only by those who are responsible and are authorized to do so.
- Stop the engine, lower all equipment, lock the brakes, and remove the ignition key before dismounting from the tractor.
- Never stand between tractor and implement while tractor is being backed to hitch.
- Loose fitting clothing should not be worn, to avoid catching on various parts.
- Detach implement in area where children normally do not play.
- When performing adjustments or maintenance on an implement, first lower it to the ground or block it securely at a workable height.
- Only a qualified operator should be permitted on tractor when in operation; no riders allowed.
- Make certain everyone is in the clear before starting tractor or raising or lowering equipment.
- Operate the tractor and implement only while seated in the driver's seat.
- Reduce speed when transporting mounted implements to avoid bouncing and momentary loss of steering control.
- A heavy load can cause instability of the tractor. Use extreme care during road travel. Slow down on turns and watch out for bumps. Tractor may need front counterweights to counter-balance the weight of the implement.
- Reduce speed on hillsides or curves so there is no danger of tipping.
- Avoid driving too close to the edge of ditches or creeks.
- Do not transport implement on public roads without reflectors and slow moving vehicle emblem in daylight and with approved warning lights at night and other periods of poor visibility.
- Due to the width of some implements, use extra caution on highways, farm roads, and when approaching gates.
- Always be sure the implement is in the proper position for transport.
- Keep alert and watch the front as well as the rear when working with the implement.

OWNER'S/ OPERATOR'S MANUAL

MODEL NO.'s

SG-26A

SG-36A

**WHEN ORDERING REPAIR
PARTS, ALWAYS GIVE THE
FOLLOWING INFORMATION:**

1. PART NUMBER
2. PART DESCRIPTION
3. MODEL NUMBER
4. NAME OF ITEM

MAY 2013

STUMP GRINDERS for TRACTORS

**Please work, drive, play and live each day with
care and concern for your safety and that of your
family and fellow citizens.**

**MAKE EVERY DAY
A HOLIDAY
FROM ACCIDENTS**

WORKSAVER, INC.

P.O. BOX 100 LITCHFIELD, IL 62056-0100 (217) 324-5973
WEB: <http://www.worksaver.com> E-MAIL: sales@worksaver.com