

OWNER'S/ OPERATOR'S MANUAL

MODEL NO.'s

614H

624H

714H

724H

814H

824H

924H

(#030800001 AND UP)

CAUTION

For Safe Operation
Read Rules And
Instructions Carefully

SINO LEEINGLES, PIDA AYUDA
A AIGUIEN QUE SI LO LEA
PARA QUE LE TRADUZCA LAS
MEDIDAS DE SEGURIDAD.

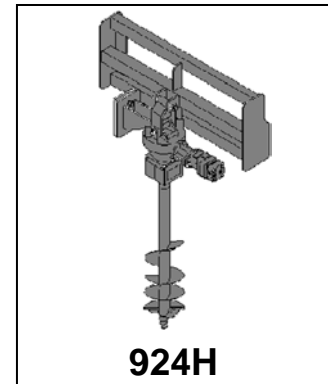
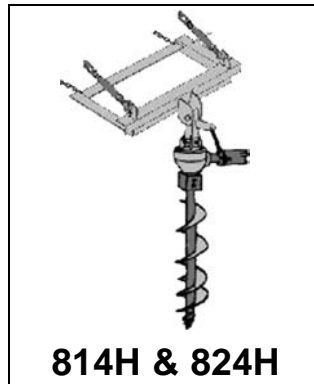
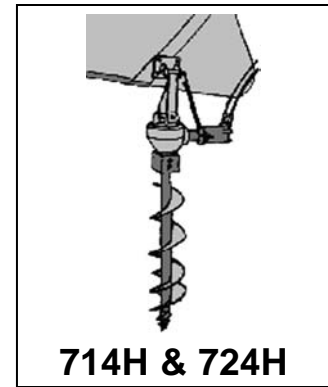
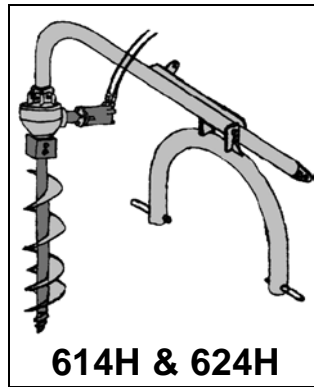

HYDRAULIC POST HOLE DIGGERS

Safety Instructions
Tractor Preparation
Operating Instructions

Assembly & Mounting
Maintenance
Repair Parts

CAUTION

THE FOLLOWING SAFETY PRECAUTIONS SHOULD BE THOROUGHLY UNDERSTOOD BEFORE ATTEMPTING TO BEGIN ASSEMBLING THIS MACHINE

1. Select an area for assembly that is clean and free of any debris which might cause persons working on the assembly to trip.
2. Do not lift heavy parts or assemblies. Use crane, jack, tackle, fork trucks or other mechanical devices.
3. Preview the assembly instructions in your operator's manual before proceeding further.
4. If the assembly instructions call for parts or assemblies to be blocked up, use only blocking material that is in good condition and is capable of handling the weight of the assembly to be blocked. Also insure that the blocking material is on a clean, dry surface.
5. Never put hands, or any part of body, under blocked up assemblies if at all possible.
6. After completing assembly, thoroughly inspect the machine to be sure that all nuts, bolts, hydraulic fittings or any other fastened assemblies have been thoroughly tightened.
7. Before operating the machine, thoroughly read the operation section of your operator's manual.
8. Before operating, read the maintenance section of your operator's manual to be sure that any parts requiring lubrication, such as gearboxes, are full, to avoid any possible damage.
9. **Before operating equipment – If you have any questions regarding the proper assembly or operation, contact your dealer or representative.**

TABLE OF CONTENTS

WARRANTY	2
SAFETY INFORMATION	3-12
SAFETY SIGNS	12-13
PREPARATION INSTRUCTIONS	14-17
OPERATING INSTRUCTIONS	18-20
OWNER SERVICE/SPECIFICATIONS	21
TROUBLE-SHOOTING GUIDE	22-23
PARTS LISTS	24-30

SINO LEEINGLES, PIDA AYUDA A AIGUIEN QUE SI LO LEA PARA QUE LE TRADUZCA LAS MEDIDAS DE SEGURIDAD.

STATEMENT OF POLICY

It is the policy of Worksaver, Inc. to improve its products where it is possible and practical to do so. Worksaver, Inc. reserves the right to make changes or improvements in design and construction at any time, without incurring the obligation to make these changes on previously manufactured units.

TO THE OWNER:

Read this manual before using your Hydraulic Post Hole Digger. This manual is provided to give you the necessary operating and maintenance instructions for keeping your post hole digger in top operating condition. Please read this manual thoroughly. Understand what each control is for and how to use it. Observe all safety signs on the machine and noted throughout the manual for safe operation of implement. Keep this manual handy for ready reference.

Like all mechanical products, it will require cleaning and upkeep. Lubricate the Digger as specified.

Use only genuine Worksaver, Inc. service parts. Substitute parts will void the warranty and may not meet standards required for safe and satisfactory operation. Record the model and serial number of your Post Hole Digger here:

Model: _____ Serial Number: _____

RETAIL CUSTOMER'S RESPONSIBILITY

It is the Retail Customer and/or Operator's responsibility to read the Operator's Manual, to operate, lubricate, maintain, and store the product in accordance with all instructions and safety procedures. Failure of the operator to read the Operator's Manual is a misuse of this equipment.

It is the Retail Customer and/or Operator's responsibility to inspect the product and to have any part(s) repaired or replaced when continued operation would cause damage or excessive wear to other parts or cause a safety hazard.

It is the Retail Customer's responsibility to deliver the product to the authorized Worksaver Dealer, from whom he purchased it, for service or replacement of defective parts which are covered by warranty. Repairs to be submitted for warranty consideration must be made within forty-five (45) days of failure.

It is the Retail Customer's responsibility for any cost incurred by the Dealer for traveling to or hauling of the product for the purpose of performing a warranty obligation or inspection.

LIMITED WARRANTY

Worksaver warrants to the original purchaser of any new Hydraulic Post Hole Digger (Models 614H, 624H, 714H, 724H, 814H, 824H and 924H), that the equipment be free from defects in material and workmanship for a period of one (1) year for non-commercial, state, and municipalities. Use ninety (90) days for commercial use from date of retail sale.

Replacement or repair parts installed in the equipment covered by this warranty are warranted for ninety (90) days from the date of purchase of such part or to the expiration of the applicable new equipment warranty period, whichever occurs later.

Such parts shall be provided at no cost to the user during regular working hours. Worksaver reserves the right to inspect any equipment or parts which are claimed to have been defective in material or workmanship.

DISCLAIMER OF IMPLIED WARRANTIES & CONSEQUENTIAL DAMAGES

Worksaver's obligation under this warranty, to the extent allowed by law, is in lieu of all warranties, implied or expressed, including implied warranties of merchantability and fitness for a particular purpose and any liability for incidental and consequential damages with respect to the sale or use of the items warranted. Such incidental and consequential damages shall include but not be limited to: transportation charges other than normal freight charges; cost of installation other than cost approved by Worksaver; duty; taxes; charges for normal service or adjustments; loss of crops or any other loss of income; rental of substitute equipment, expenses due to loss, damage, detention or delay in the delivery of equipment or parts resulting from acts beyond the control of Worksaver.

THIS WARRANTY SHALL NOT APPLY:

1. Worksaver is NOT responsible for damage to augers caused by hitting underground objects (rocks, roots, etc.) or for bent augers caused by moving the tractor with the auger in the ground.
2. To vendor items which carry their own warranties, such as hydraulic motors, tires, and tubes.
3. If the unit has been subjected to misapplication, abuse, misuse, negligence, fire or other accident.
4. If parts not made or supplied by Worksaver have been used in connection with the unit, if, in sole judgement of Worksaver such use affects its performance, stability, or reliability.
5. If the unit has been altered or repaired outside of an authorized Worksaver dealership in a manner which, in the sole judgement of Worksaver affects its performance, stability or reliability.
6. To normal maintenance service and normal replacement items such as gearbox lubricant, hydraulic fluid, worn blades, or to normal deterioration of such things as belts and exterior finish, due to use or exposure.
7. To expendable or wear items such as teeth, chains, sprockets, belts, springs and other items that in the company's sole judgement is a wear item.

ADDITIONS TO LIMITED WARRANTY

In addition to the Limited Warranty printed above, **Worksaver, Inc.** provides:

1. Five years' (60 months) warranty on the gearbox for farm use and 1 year (12 months) for commercial use and;
2. Three years' (36 months) warranty on hydraulic motor for farm use and six (6) months for commercial use
IF

all of these components have been properly maintained and lubricated and that they have not been subjected to abuse or misuse.

NO EMPLOYEE OR REPRESENTATIVE OF WORKSAVER IS AUTHORIZED TO CHANGE THIS WARRANTY IN ANY WAY OR GRANT ANY OTHER WARRANTY UNLESS SUCH CHANGE IS MADE IN WRITING AND SIGNED BY WORKSAVER'S SERVICE MANAGER, POST OFFICE BOX 100, LITCHFIELD, ILLINOIS 62056-0100.

To the Owner/Operator/Dealer

All implements with moving parts are potentially hazardous. There is no substitute for a cautious, safe-minded operator who recognizes the potential hazards and follows reasonable safety practices. The manufacturer has designed this implement to be used with all its safety equipment properly attached to minimize the chance of accidents.

BEFORE YOU START!!

Read the safety messages on the implement and shown in your manual.
Observe the rules of safety and common sense!



THIS SYMBOL MEANS

- ATTENTION!
- BECOME ALERT!
- YOUR SAFETY IS INVOLVED!

THIS SAFETY ALERT SYMBOL IDENTIFIES IMPORTANT SAFETY WARNING MESSAGES. CAREFULLY READ EACH WARNING MESSAGE THAT FOLLOWS. FAILURE TO UNDERSTAND AND OBEY A SAFETY WARNING, OR RECOGNIZE A SAFETY HAZARD, COULD RESULT IN AN INJURY OR DEATH TO YOU OR OTHERS AROUND YOU. THE OPERATOR IS ULTIMATELY RESPONSIBLE FOR THE SAFETY OF HIMSELF, AS WELL AS OTHERS, IN THE OPERATING AREA OF THE TRACTOR AND ATTACHED EQUIPMENT.

UNDERSTAND SIGNAL WORDS

Note the use of the signal words **DANGER**, **WARNING** and **CAUTION** with the safety messages. The appropriate signal word for each has been selected using the following guidelines:

DANGER: Indicates an imminently hazardous situation that, if not avoided, will result in death or serious injury. This signal word is to be limited to the most extreme situations typically for machine components which, for functional purposes, cannot be guarded.

WARNING: Indicates a potentially hazardous situation that, if not avoided, could result in death or serious injury, and includes hazards that are exposed when guards are removed. It may also be used to alert against unsafe practices.

CAUTION: Indicates a potentially hazardous situation that, if not avoided, may result in minor or moderate injury. It may also be used to alert against unsafe practices.

If you have questions not answered in this manual or require additional copies or the manual is damaged, please contact your dealer or the manufacturer directly.

IMPORTANT SAFETY INFORMATION!

Working with unfamiliar equipment can lead to careless injuries. Read this manual, and the manual for your tractor, before assembly or operating, to acquaint yourself with the machines. It is the implement owner's responsibility, if this machine is used by any person other than yourself, is loaned or rented, to make certain that the operator, prior to operating:

1. Reads and understands the operator's manuals.
2. Is instructed in safe and proper use.



The use of this equipment is subject to certain hazards which cannot be protected against by mechanical means or product design. All operators of this equipment must read and understand this entire manual, paying particular attention to safety and operating instructions, prior to using. If there is something in this manual you do not understand, ask your supervisor, or your dealer, to explain it to you.

SAFETY INSTRUCTIONS (continued)



EQUIPMENT SAFETY GUIDELINES



Safety of the operator is one of the main concerns in designing and developing a new piece of equipment. Designers and manufacturers build in as many safety features as possible. However, every year many accidents occur which could have been avoided by a few seconds of thought and a more careful approach to handling equipment. You, the operator, can avoid many accidents by observing the following precautions in this section. To avoid personal injury, study the following precautions and insist those working with you, or for you, follow them.



In order to provide a better view, certain photographs or illustrations in this manual may show an assembly with a safety shield removed. However, equipment should never be operated in this condition. Keep all shields in place. If shield removal becomes necessary for repairs, replace the shield prior to use.



Replace any CAUTION, WARNING, DANGER or instruction safety sign that is not readable or is missing. Location of such safety signs is indicated in this booklet.



Never use alcoholic beverages or drugs which can hinder alertness or coordination while operating this equipment. Consult your doctor about operating this machine while taking prescription medications.



Review the safety instructions with all users annually.



This equipment is dangerous to children and persons unfamiliar with its operation. The operator should be a responsible adult familiar with farm machinery and trained in this equipment's operations. **Do not allow persons to operate or assemble this unit until they have read this manual and have developed a thorough understanding of the safety precautions and of how it works.**



To prevent injury or death, use a tractor equipped with a Roll-Over Protective System (ROPS). Do not paint over, remove or deface any safety signs or warning signs on your equipment. Observe all safety signs and practice the instruction on them.



Never exceed the limits of a piece of machinery. If its ability to do a job, or to do so safely, is in question – **DON'T TRY IT.**



Do not modify the equipment in any way. Unauthorized modification may impair the function and/or safety and could affect the life of the equipment.







In addition to the design and configuration of this implement, including Safety Signs and Safety Equipment, hazard control and accident prevention are dependent upon the awareness, concern, prudence, and proper training of personnel involved in the operation, transport, maintenance, and storage of the machine. Refer also to Safety Messages and Operation Instructions in each of the appropriate sections of the Tractor and Implement Manuals. Pay close attention to the Safety Signs affixed to the Tractor and the Implement.





SAFETY INSTRUCTIONS (continued)



SAFETY SIGNS







-  Keep safety signs clean and legible at all times.
-  Replace safety signs that are missing or have become illegible.
-  Replaced parts that displayed a safety sign should also display the current sign.
-  Safety signs are available from your Distributor or Dealer Parts Department or the factory.

How to Install Safety Signs:

-  Be sure that the installation area is clean and dry. Be sure temperature is above 50°F (10°C).
-  Decide on the exact position before you remove the backing paper.
-  Remove the smallest portion of the split backing paper. Align the sign over the specified area and carefully press the small portion with the exposed sticky backing in place.
-  Slowly peel back the remaining paper and carefully smooth the remaining portion of the sign in place. Small air pockets can be pierced with a pin and smoothed out using the piece of sign backing paper.



SAFETY TRAINING

-  Safety is a primary concern in the design and manufacture of our products. Unfortunately, our efforts to provide safe equipment can be wiped out by a single careless act of an operator. It is the operator's responsibility to read and understand ALL Safety and Operating instructions in the manual and to follow these. Accidents can be avoided.
-  In addition to the design and configuration of equipment, hazard control and accident prevention are dependent upon the awareness, concern, prudence and proper training of personnel involved in the operation, transport, maintenance and storage of equipment.
-  Working with unfamiliar equipment can lead to careless injuries. Read this manual, and the manual for your tractor, before assembly or operating, to acquaint yourself with the machines. It is the rotary mower owner's responsibility, if this machine is used by any person other than yourself, is loaned or rented, to make certain that the operator, prior to operating:
 1. Reads and understands the operator's manuals.
 2. Is instructed in safe and proper use.
-  Know your controls and how to stop tractor, engine, and implement quickly in an emergency. Read this manual and the one provided with your tractor.
-  Train all new personnel and review instructions frequently with existing workers. A person who has not read and understood all operating and safety instructions is not qualified to operate the machine. An untrained operator exposes himself and bystanders to possible serious injury or death.
-  Do not allow children to operate this machine.

SAFETY INSTRUCTIONS (continued)





PREPARATION

-  Personal protection equipment including hard hat, safety glasses, safety shoes, and gloves are recommended during assembly, installation, operation, adjustment, maintaining, repairing, removal, or moving the implement. Do not allow long hair, loose fitting clothing or jewelry to be around moving parts.

-  **PROLONGED EXPOSURE TO LOUD NOISE MAY CAUSE PERMANENT HEARING LOSS!**
Tractors with or without implements attached can often be noisy enough to cause permanent, partial hearing loss. We recommend that you wear hearing protection on a full-time basis if the noise in the Operator's position exceeds 80db. Noise over 85db on a long-term basis can cause severe hearing loss. Noise over 90db adjacent to the Operator over a long-term basis may cause permanent, total hearing loss. **NOTE:** Hearing loss from loud noise (from tractors, chain saws, radios, and other such sources close to the ear) is cumulative over a lifetime without hope of natural recovery.

-  Clear area of stones, branches or other debris that might be thrown, causing injury or damage.

-  Operate only in daylight or good artificial light.

-  Ensure that all safety shielding and safety signs are properly installed and in good condition.



OPERATIONAL SAFETY

-  This Post Hole Digger was designed for one-man operation from the tractor seat. It is the responsibility of the operator to see that no one is within twenty-five feet (25') of the digger when it is started. Do not operate the digger with another person near, or in contact with, any part of the digger, PTO driveline, or auger. Serious personal injury or death may result if any attempt is made to assist digger operation by hand.

-  Most accidents occur because of neglect or carelessness. Keep all helpers and bystanders twenty-five feet (25') from an operating digger. Only properly trained people should operate this machine. It is recommended the tractor be equipped with a Rollover Protection System (ROPS) and a seat belt that is used. Always stop the PTO, set brake, shut off the tractor engine, remove the tractor key, and allow auger to come to a complete stop before dismounting tractor. Never leave equipment unattended with the tractor running.

















-  All things with moving parts are potentially hazardous. There is no substitute for a cautious, safe-minded operator who recognizes potential hazards and follows reasonable safety practices. The manufacturer has designed this digger to be used with all its safety equipment properly attached, to minimize the chance of accidents. Study this manual to make sure you have all safety equipment attached.

-  If a safety shield or guard is removed for any reason, it must be replaced before the machine is again operated. Always use, and maintain in place, all power take off guards furnished with the tractor as well as the power take off guards and shields furnished with the digger.

SAFETY INSTRUCTIONS (continued)



















OPERATIONAL SAFETY (continued)

-  The use of any loader attachment is NOT recommended on tractor with a tricycle wheel arrangement. Tricycle type tractors are unstable for front loader use.
-  When the use of hand tools is required to perform any part of assembly, installation, adjustment, maintaining, repairing, removal, or moving the digger, be sure the tools used are designed and recommended by the tool manufacturer for that specific task.
-  Never place yourself between the tractor and digger while implement is in operation.
-  Do not walk or work under a raised digger or attachment unless it is securely blocked or held in position. Do not depend on the tractor hydraulic system to hold the digger or attachment in place.
-  A heavy load can cause instability of the tractor. Use extreme care during travel. Slow down on turns and watch out for bumps. The tractor may need counter-weights to counter-balance the weight of the digger.
-  Never use alcoholic beverages or drugs which can hinder alertness or coordination while operating this equipment. Consult your doctor about operating this machine while taking prescription medications.
-  Never permit any person other than the operator to ride or board the tractor or implement at any time. **ALLOW NO RIDERS!**
-  Before you operate the digger, check over all pins, bolts and connections to be sure all are securely in place. Replace any damaged or worn parts immediately.
-  Consult local utility companies to make certain there are no buried gas lines, electrical cables, etc., in the work area before beginning operation.
-  Do not allow anyone who is not familiar with the safety rules and operation instructions to use this Post Hole Digger.
-  Never allow children to operate or be around this digger.
-  Use stabilizer bars, adjustable sway chains, or sway blocks on your tractor lift arms to keep the Post Hole Digger from swinging side to side. Adjust as tightly as practical for best performance.
-  Never replace the shear bolt OR auger retaining bolt with any length other than what is specified in this manual. A longer, or protruding fastener is more likely to grab loose clothing or gloves which can result in serious injury or death.
-  Do not operate digger on steep hillsides. When digging on uneven or hilly terrain, position the tractor with the Post Hole Digger uphill. With the Post Hole Digger downhill, the tractor could tip when attempting to pull the auger from its hole.
-  Never position the auger point by hand or with any tool when the tractor is running.
-  Never position the auger point by putting your hands on the auger, gearbox, boom, or driveline.

SAFETY INSTRUCTIONS (continued)













OPERATIONAL SAFETY (continued)

-  A heavy load can cause instability in driving a tractor. Make sure the front or rear of the tractor is properly counter-balanced with weights. Always drive slowly – especially around turns. An unstable tractor could steer badly and possibly tip over, causing injury or death.
-  Most accidents occur because of neglect or carelessness. Keep all helpers and bystanders at a safe distance.
-  Beware of low electrical wires when loader is raised. Serious injury or death can result if contact is made.
-  Beware of lift clearance when raising loader to maximum height.
-  Keep alert and watch the rear as well as the front when working with the loader.
-  When maneuvering close to buildings or passing through narrow areas, be sure to allow sufficient clearance for the tractor, loader, and attachment. Drive slowly.
-  Operate loader from operator's seat only. Remain at controls until operating cycle is complete.
-  Stop loader gradually when lowering or lifting loads. Operate loader controls smoothly, avoid jerky operation.
-  Allow for additional length of loader and attachment on tractor while turning.
-  Be sure that people, livestock, or pets are not standing near the machine while operating.
-  Only use a tractor equipped with a ROPS cab or rollover protective structure.
-  Do not lift or carry anyone on loader or in bucket or on attachment. Do not use loader for a work platform.
-  ALWAYS lower loader to the ground or block securely before performing any maintenance work.
-  Stay alert for holes, rocks and roots in the terrain and other hidden hazards. Keep away from drop-offs.
-  Use extreme care and maintain minimum ground speed when transporting on hillside, over rough ground and when operating close to ditches or fences. Be careful when turning sharp corners.
-  Reduce speed on slopes and sharp turns to minimize tipping or loss of control. Be careful when changing directions on slopes. Do not start or stop suddenly on slopes. Avoid operation on steep slopes.

SAFETY INSTRUCTIONS (continued)





OPERATIONAL SAFETY (continued)

-  Inspect the entire machine periodically as indicated in the Maintenance Section of this manual. Look for loose fasteners, worn or broken parts, pinched hydraulic hoses, and leaky or loose fittings. Make sure all pins have cotter pins and washers. Serious injury may occur from not maintaining this machine in good working order.
-  When using a unit, a minimum 20% of tractor and equipment weight must be on tractor front wheels. Without this weight, tractor could tip over, causing personal injury or death. The weight may be attained with a front end loader, front wheel weights, ballast in tires or front tractor weights. When attaining a minimum 20% of tractor and equipment weight on the front wheels, you must not exceed the ROPS weight certification. Weigh the tractor and equipment. Do not guess or estimate!
-  Avoid excessive speed during operation.
-  Keep hands, feet, hair, jewelry, and clothing, away from all moving and/or rotating parts.
-  To prevent entanglement and possible serious injury or death, never use body weight to try to push auger into the ground.
-  Worn edges or a slightly rounded point can seriously effect auger penetration. Check for wear before each use, replace as necessary.
-  Do not shovel dirt away from a rotating auger as the shovel can be caught and thrown by the auger.
-  Before operating equipment: if you have any questions regarding the proper assembly or operation, contact your dealer or representative.
-  Always shut off tractor and shift to "Park" or set brakes when leaving tractor. Always lower bucket or attachment to ground. Remove key when leaving tractor unattended.
-  Always use care when operating a Post Hole Digger.



MAINTENANCE SAFETY

-  Good maintenance is your responsibility. Poor maintenance is an invitation to trouble.
-  Follow good shop practices.
 - Keep service area clean and dry.
 - Be sure electrical outlets and tools are properly grounded.
 - Use adequate light for the job at hand.
-  Before working on this machine, drive to a level area, disengage the PTO, lower implement (or if working underneath, raise and block securely), shut off the engine, set the brakes, and remove the ignition keys.

SAFETY INSTRUCTIONS (continued)



MAINTENANCE SAFETY



Keep all persons away from operator control area while performing adjustments, service, or maintenance.



Make sure there is plenty of ventilation. Never operate the engine of the towing vehicle in a closed building. The exhaust fumes may cause asphyxiation.



Before working on this machine, drive to a level area, relieve hydraulic pressure, lower implement (or if working underneath, raise and block securely), shut off the engine, set the brakes, and remove the ignition keys.



Never work under equipment unless it is blocked securely. Never depend on hydraulic system to keep implement in raised position.



Always use personal protection devices such as eye, hand and hearing protectors, when performing any service or maintenance.



Periodically tighten all bolts, nuts and screws and check that all cotter pins are properly installed to ensure unit is in a safe condition.



When completing a maintenance or service function, make sure all safety shields and devices are installed before placing unit in service.



Always use two people to handle heavy, unwieldy components during assembly, installation, removal, or moving the digger.



Openings in the skin and minor cuts are susceptible to infection from hydraulic fluid. If injured by escaping hydraulic fluid, see a doctor at once. Gangrene and death can result. Without immediate medical treatment, serious infection and reactions can occur.



Check to ensure all safety signs are installed and in good condition. (See safety sign section for location drawing.)







Never replace hex bolts with less than grade five bolts unless otherwise specified, i.e. shear bolts. Refer to bolt torque chart for head identification marking.

SAFETY INSTRUCTIONS (continued)



MAINTENANCE SAFETY (continued)







-  Personal protection equipment including hard hat, safety glasses, safety shoes, and gloves are recommended during assembly, installation, operation, adjustment, maintaining, repairing, removal, or moving the digger. Do not allow long hair, loose fitting clothing or jewelry to be around moving parts.
-  Where replacement parts are necessary for periodic maintenance and servicing, genuine factory replacement parts must be used to restore your equipment to original specifications. The manufacturer will not claim responsibility for use of unapproved parts and/or accessories and other damages as a result of their use.
-  If equipment has been altered in any way from original design, the manufacturer does not accept any liability for injury or warranty.
-  Never use your hands to locate a hydraulic leak on attachments. Use a small piece of cardboard or wood. Hydraulic fluid escaping under pressure can penetrate the skin. Openings in the skin and minor cuts are susceptible to infection from hydraulic fluid. If injured by escaping hydraulic fluid, see a doctor at once. Gangrene and death can result. Without immediate medical treatment, serious infection and reactions can occur.

Safety is a primary concern in the design, manufacture, sale, and use of Post Hole Diggers. As manufacturers of Post Hole Diggers, we want to confirm to you, our customers, our concern for safety.

Our current production machines include, as standard equipment, guards or shields for auger adapters, drivelines, input shafts, and safety signs. Older machines can be retrofitted to add these new guards or shields and, of course, safety signs. If you have an older machine which does not have current standard safety equipment, please contact your dealer about bringing your machine up to the current level of safety.







TRANSPORT SAFETY

-  Comply with state and local laws governing highway safety and movement of farm machinery on public roads.
-  The use of flashing amber lights is acceptable in most localities. However, some localities prohibit their use. Local laws should be checked for all highway lighting and marking requirements.
-  When driving the tractor and equipment on the road or highway under 20 mph (32 kph) at night or during the day, use flashing amber warning lights and a slow moving vehicle (SMV) identification emblem.
-  Always be sure the implement is in the proper raised position for transport.
-  Reduce speed when transporting mounted implements to avoid bouncing and momentary loss of steering control.
-  Turn curves or go up or down hills only at a low speed and at a gradual steering angle. Make certain that at least 20% of the tractor's weight is on the front wheels to maintain safe steering. Slow down on rough or uneven surfaces, and loose gravel.

SAFETY INSTRUCTIONS (continued)



STORAGE SAFETY

-  Following operation or when unhooking, stop the tractor, set the brakes, disengage the PTO, shut off the engine and remove the ignition keys.
-  Store the unit in an area away from human activity. Do not permit children to play on or around the stored unit.
-  Do not park equipment where it will be exposed to livestock for long periods of time. Damage and livestock injury could result.
-  Make sure all parked machines are on a hard, level surface and engage all safety devices.
-  If blocking is used, make sure it is solid and secure before leaving area.

SAFETY SIGNS

 WARNING	
	
HIGH-PRESSURE FLUID HAZARD To prevent serious injury or death: <ul style="list-style-type: none">• Relieve pressure on system before repairing or adjusting or disconnecting.• Wear proper hand and eye protection when searching for leaks. Use wood or cardboard instead of hands.• Keep all components in good repair.	
SW700	

 WARNING
Keep shields in down position during operation. Failure to do so can result in severe personal injury.
101186

LOCATED ON GEARBOX OUTPUT SHIELD

SAFETY SIGNS (continued)

POST HOLE DIGGER INSTRUCTIONS

1. Fill gearbox to the inspection hole with number 90 weight transmission grease. Check often.
2. Grease universal joints regularly. Check often.
3. Attach stabilizer bars to prevent side swing.
4. Replace shear bolt only with common grade #2 bolts. The use of a hard shear bolt voids all warranty.
5. Disengage PTO when moving.
6. Lift auger periodically to clear hole.
7. **DO NOT LET AUGER SCREW INTO GROUND. HOLD BACK WITH HYDRAULIC LIFT SO IT DIGS. DAMAGE TO DIGGER MAY OCCUR IF NOT PROPERLY OPERATED. DO NOT MOVE TRACTOR WITH AUGER IN GROUND.**

101015

DANGER

KEEP CLEAR!
ENTANGLEMENT CAN
CAUSE SERIOUS BODILY
INJURY OR DEATH.

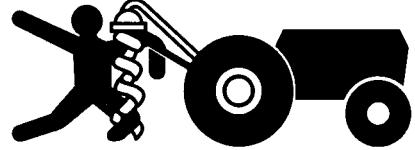

1. OPERATOR MUST ALWAYS STAY ON TRACTOR SEAT.
2. NEVER OPERATE IF ANYONE IS WITHIN TWENTY-FIVE (25) FEET OF AUGER.
3. NEVER ATTEMPT TO HANG ON THE DIGGER TO FORCE IT INTO GROUND — SEVERE INJURY OR DEATH COULD OCCUR.

101032

DANGER DANGER DANGER

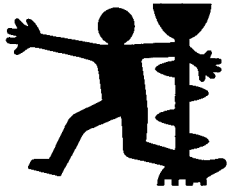

Rotating Parts Hazard Keep Away

*To Prevent Serious Injury or Death from Rotating Parts:
 - Si no entiende ingles, se prefiere que busque a alguien que interprete las instrucciones para usted.*

- Read and understand owner's manual before operating.
- Do not operate without all shields and guards in place.
- Do not use body weight to force the auger into the ground or to locate auger point when auger is turning.
- Keep away from auger, cutting head and driveline when engine is running.



WS101130

LOCATED ON POST HOLE DIGGER BOOM

DANGER

GUARD MISSING
 When this is visible
DO NOT OPERATE



KEEP CLEAR!
 Keep Others Away!
ENTANGLEMENT HAZARD
can cause Serious Injury or Death

Si no entiende ingles, se prefiere que busque a alguien que interprete las instrucciones para usted.

- Never manually position the auger or manually force the auger into ground.
- This machine is designed to be operated ONLY from the tractor seat.
- Keep everyone clear of all moving parts of the digger while in operation.

WS101131

LOCATED AT TOP OF AUGER CENTER TUBE

REMEMBER: If Safety Signs have been damaged, removed, become illegible or parts replaced without Signs, new Safety Signs must be applied. New Safety Signs are available from your authorized distributor or factory.

INSTRUCTIONS

TRACTOR AND LOADER REQUIREMENTS AND PREPARATION

The seven models of hydraulic post hole diggers are designed to meet the various mounting applications requested by customers.

MODELS 614H and 624H are 3-pt. mounted post hole diggers that will fit most Category I and Category II tractors equipped with a standard 3-pt. hitch.

Tractor must be equipped with stabilizer bars, adjustable sway chains, or sway blocks to keep the post hole digger from swinging side to side.

Smaller size tractors may need front counter weights to counter-balance the weight of the post hole digger and the weight of the dirt on the auger (when using large diameter augers).

Check the tractor's 3-pt. hydraulic lift system. It should operate up and down smoothly and have enough power to lift the dirt-loaded auger out of the hole. Refer to your tractor operator's manual or dealer for any adjustments necessary to put the 3-pt. hydraulic lift system in good working order. (I&T shop manuals will list most specifications and adjustment instructions - available from most farm equipment dealers.)

MODELS 714H and 724H use a bolt-on mounting plate that are designed primarily for bolting on to the end plates of a front loader bucket, but are adaptable to other mounting applications.

MODELS 814H and 824H clamp-on to tractor front loaders or skid steer loader buckets.

The post hole diggers are easily installed or removed from your front loader in minutes. A chain and turnbuckle provide a secure, easy means of clamping the attachment to your loader bucket.

It is recommended that only tractors with wide front axles be used with this implement. Tricycle front wheel arrangements are inherently unstable and tractor roll-over accidents are more likely to occur.



The use of any loader attachment is **NOT** recommended on tractors with a tricycle wheel arrangement. Tricycle type tractors are unstable for front loader use.

It is recommended that the tractor be equipped with a Rollover Protection System (ROPS) and a seat belt that is used.



Be sure your tractor or skid steer is in good condition. Read all the safety precautions and make sure all operators are familiar with the safety rules of operation.

Check your tractor and front loader or skid steer to make sure they are in good working condition. Check all frame mounting bolts to make sure they are tight.

Loaders that attach to the tractor frame rails should have a cross-tie installed for stability.

MODEL 924H is for mounting directly on skid steer units with the universal quick-attach bucket mount.

The bucket is removed and a separate post hole digger mounting frame is used.

ALL MODELS

Check the hydraulic system. Be sure the hydraulic oil and filter have been serviced according to the manufacturer's recommendations.

NOTE: Models ending with **14H** are for 5-10 gpm systems @1500-3000 psi.

NOTE: Models ending with **24H** are for 10-20 gpm systems @1500-3000 psi.

The required size of the tractor and front loader or skid steer will be determined by the weight of the load to be handled.

Always use a tractor and front loader or skid steer large enough to safely handle the load.



A heavy load can cause instability in driving a tractor. Make sure the front or rear of the tractor is properly counter-balanced with weights. Always drive slowly – especially around turns. An unstable tractor could steer badly and possibly tip over, causing injury or death.

INSTRUCTIONS (continued)

ASSEMBLY AND MOUNTING

3 PT. MODELS 614H and 624H

Unpack all the bundles and lay out various parts. Start with the yoke. Place the pull pins through the holes in the legs of the yoke and secure with nuts and lock washers.

NOTE: If your tractor lift arm spacing is 32", place the pull pins on the outside of the yoke legs as shown in parts diagram. If your tractor lift arm spacing is 26" or less, then place the pull pins on the inner side of the yoke legs. The pins are Category I ($\frac{7}{8}$ " dia.). If your tractor is Category II, then lift arm bushings are required to properly fit the $1\frac{1}{8}$ " dia. Cat. II lift arm balls. (Bushings not supplied.) Place the lift arms of your tractor over the pull pins in the yoke and secure with linchpins (not supplied).

Place the tractor end of the digger boom between the top link ears on your tractor and pin in place. Use bushing for Cat. I tractors ($\frac{3}{4}$ " dia.). Swing the yoke up and attach it to the boom with the mounting pin and secure it with cotter pins.

NOTE: Always use adapter bushings when using Category I pins on a Category II hitch. Trying to use Cat. I pins in a Cat. II hitch without bushings will result in a very sloppy fit and the post hole digger will be unstable.

NOTE: When attaching the yoke to the boom, use the hole in the adjustment channel best suited for your tractor. If you don't know the best hole location, start with the middle hole.

Install shields on output end of gearbox. A socket with a long extension is the best tool for easy installation. Check exploded parts drawing for correct position.

NOTE: It is easier to install the guards on the gearbox before installing the gearbox on the post hole digger.



Do not operate this equipment without shields properly installed. This is for your protection, and the manufacturer recommends the use of these shields at all times while operating this post hole digger.

Attach the gearbox with hydraulic motor and counterweight bracket to the boom using the gearbox pin and secure it with the two cotter pins. The gearbox should be placed so that the large shaft is pointing toward the ground and the hydraulic motor is pointing toward the tractor.

NOTE: The gearbox is shipped **WITHOUT** lubricant, so it will be necessary to fill it before use. With the gearbox in a level position, fill to the side inspection hole with a good 90 wt. gear lubricant. Gearbox holds 86 fluid oz. Check often and add lubricant if necessary.

To dig properly, your digger must be able to raise or lower through the highest and lowest points of your lift arm travel without binding against the tractor frame. Check carefully **BEFORE** attaching the auger. If it does bind, adjust the tractor 3-pt. linkage so that all movement is free.

ASSEMBLY AND MOUNTING

BOLT-ON MODELS 714H and 724H

It is recommended that the bolt-on bracket be mounted on the right hand side of the loader bucket as this is the non-traffic side during road transport. The unit may be mounted on either side.

Hold the mounting plate on the side of the loader bucket and mark the four hole locations. Drill four $\frac{21}{32}$ diameter holes in the bucket end plate.

Bolt the mounting bracket to the bucket with the reinforcement mounting plate on the inside. Failure to use the reinforcement plate will cause the bolts to pull through the holes in the sheet metal bucket end plate.

Install shields on output end of gearbox. A socket with a long extension is the best tool for easy installation. Check exploded parts drawing for correct position.

NOTE: It is easier to install the guards on the gearbox before installing the gearbox on the post hole digger mount.

Attach the gearbox with hydraulic motor and counterweight bracket to the pivot bracket weldment using the gearbox pin and secure it with the two cotter pins. Then connect the entire assembly to the mounting bracket with the 1" bolt. The gearbox should be placed so that the large shaft is pointing toward the ground and the hydraulic motor is pointing toward the tractor.

NOTE: The gearbox is shipped **WITHOUT** lubricant, so it will be necessary to fill it before use. With the gearbox in a level position, fill to the side inspection hole with a good 90 wt. gear lubricant. Gearbox holds 86 fluid oz. Check often and add lubricant if necessary.

OBEY ALL SAFETY WARNINGS!

INSTRUCTIONS (continued)

ASSEMBLY AND MOUNTING

CLAMP-ON MODELS 814H and 824H

Check your loader to make sure it is in good working order.

Refer to the exploded parts views in this manual for proper orientation of the chain, bolt, and washer.

Install the chain on the clamp-on attachment with the 1/2" hex bolt and locknut provided. Make sure that the flat washer is next to the chain link to provide more support for the chain.

Install the turnbuckle on the bucket attachment with the pin and cotter pins. Check the turnbuckle to make sure that it operates easily. Spreading some grease on the threads will help insure that it will remain free and easy to use.

Slide the front cutting edge of your loader bucket under the lip of the bucket attachment.

Raise the loader slightly so that the bottom of clamp-on attachment is about three or four feet off the ground. Engage tractor parking brake and shut off the engine.

Place some solid blocking under the bottom of the bucket for safety.

Install the chain around the loader bucket and into the keyhole slot on the upper end of the turnbuckle. Slide the chain through the keyhole slot until the chain around the bucket is fairly tight – then tighten by turning the turnbuckle body. Tighten the chain so that the loader attachment and chain are fastened to the loader bucket.

Do not overtighten as damage to the bucket can occur.

If necessary, loosen the turnbuckle and relocate the keyhole slotted end to another chain link and retighten the turnbuckle.

Turn the locknut on the turnbuckle up tight against the end of the turnbuckle barrel and tighten with a wrench.



DO NOT operate loader and attachment if it is not securely fastened to the loader bucket. If loose, the attachment could come off the loader bucket creating a dangerous situation that could lead to personal injury or death.

Install shields on output end of gearbox. A socket with a long extension is the best tool for easy installation. Check exploded parts drawing for correct position.

NOTE: It is easier to install the guards on the gearbox before installing the gearbox on the post hole digger.



Do not operate this equipment without shields properly installed. This is for your protection, and the manufacturer recommends the use of these shields at all times while operating this post hole digger.

Attach the gearbox with hydraulic motor and counter-weight bracket to the pivot bracket weldment using the gearbox pin and secure it with the two cotter pins. Then connect the entire assembly to the clamp-on mounting bracket with the 1" bolt. The gearbox should be placed so that the large shaft is pointing toward the ground and the hydraulic motor is pointing toward the tractor.

NOTE: The gearbox is shipped **WITHOUT** lubricant, so it will be necessary to fill it before use. With the gearbox in a level position, fill to the side inspection hole with a good 90 wt. gear lubricant. Gearbox holds 86 fluid oz. Check often and add lubricant if necessary.

ASSEMBLY AND MOUNTING

MODEL 924H

The Model 924H is designed to fit skid steer units with the "Universal" (Bobcat) style quick-attach loaders.

Remove the bucket from your Skid Steer unit. Check the loader arms and cylinders to make sure they are in good working order. Lubricate all loader pivot points. Check all bolts to make sure they are in place and tight.

Be sure the skid steer hydraulic oil and filter have been serviced according to the skid steer manufacturer's recommendations.

Refer to the "exploded view" of the skid steer mounted post hole digger on page 30 of this manual. Become familiar with the relationship of the various components and parts shown.

Connect the post hole digger mount frame to the "universal" quick-attach plate on your skid steer loader. Flip the spring loaded latch pins to the "latch lock" position and check to see they are properly latched

Raise the unit about 3 1/2 feet from the ground.

Install shields on output end of gearbox. A socket with a long extension is the best tool for easy installation.

NOTE: It is easier to install the guards on the gearbox before installing the gearbox on the post hole digger.

INSTRUCTIONS (continued)

ASSEMBLY AND MOUNTING

MODEL 924H (continued)



Do not operate this equipment without shields properly installed. This is for your protection, and the manufacturer recommends the use of these shields at all times while operating this post hole digger.

Attach the gearbox with hydraulic motor and counterweight bracket to the pivot bracket weldment using the gearbox pin and secure it with the two cotter pins. Then connect the entire assembly to the main frame pivot ears with the 1" bolt. The gearbox should be placed so that the large shaft is pointing toward the ground and the hydraulic motor is pointing toward the tractor.

NOTE: The gearbox is shipped **WITHOUT** lubricant, so it will be necessary to fill it before use. With the gearbox in a level position, fill to the side inspection hole with a good 90 wt. gear lubricant. Gearbox holds 86 fluid oz. Check often and add lubricant if necessary.

FINAL ASSEMBLY – ALL UNITS

Bolt the steel plate counterweights to the counterweight bracket.

The hoses and fittings are included on the Model 614H and 624H (3 pt. models). They are also included for the Model 924H. With these models, the length of hose can be predetermined.

For the Models 714H, 724H, 814H and 824H, the length of hose required can vary and are not included.

Measure for the hydraulic hose requirement for the motor. Be sure to allow for raising and lowering the loader and tipping the bucket. We recommend 1/2" I.D. hose rated for 2500 PSI or greater service, in accordance with your tractor system pressure. Consult your tractor owner's manual or dealer for recommendations. The ports in the hydraulic motor accept 7/8 – 14 straight thread o-ring male fittings. Use a good grade liquid thread sealant. **Do not use thread tape, as this can contaminate the hydraulic system.**

Route the hose to avoid pinching or chafing the hose. Use nylon ties or tape to fasten hose on loader arm to keep it in place.

Slide the auger over the large shaft of the gearbox and secure it with the two (2) bolts.

NOTE: Please refer to the auger bottom drawings on page 24 (Figures B, C, & D) as to the proper mounting pattern for the cutting edges. Correct mounting of the cutting edges will assure a complete cut of earth by the auger.

The digger is ready to use.

**ALWAYS OBEY ALL SAFETY RULES!
ALWAYS BE CAREFUL!**

OPERATING INSTRUCTIONS

PREPARATION PROCEDURE

- Thoroughly read and understand your Operator's Manuals.
- Before beginning operation, clear area of objects that wrap around the auger or might be thrown. Contact local utility company to make certain there are no buried gas lines, electrical cables, etc., in the work area. Check for ditches, stumps, holes, or other obstacles that could cause the tractor to roll.
- Layout and mark where you want to dig your holes.
- ALL persons should be at least twenty-five feet (25') away. Clear the area of helpers, bystanders, especially children.
- Do not allow anyone to stand behind, or to the side of a rotating auger.
- In some types of soil, it may be necessary to hold back against the auger screw suction by moving the hydraulic control lever to "HOLD" or "RAISE" position to keep the auger from screwing into the ground.
- **NEVER use body weight to help the auger penetrate the ground.** (3 pt. Hitch Models) When the ground is too tough to penetrate with your cutting edges and point, sharpen or replace them and try again. These are replaceable parts and must be in good condition to penetrate. (Optional Hydraulic Downpressure Kit is available for 3 pt. models – order #709025.)
- If you have difficulty penetrating hard ground, refer to Owner's Manual Troubleshooting section for suggestions.
- Do not shovel dirt away from a rotating auger as the shovel can be caught and thrown by the auger.
- Disengage the hydraulic oil flow when traveling between holes.

IT IS ESSENTIAL THAT EVERYONE INVOLVED IN THE ASSEMBLY, OPERATION, TRANSPORT, MAINTENANCE, AND STORAGE OF THIS EQUIPMENT BE AWARE, CONCERNED, PRUDENT, AND PROPERLY TRAINED IN SAFETY.

The post hole digger auger is free-swinging, and care should be taken while transporting the machine. **DO NOT** transport the post hole digger while the hydraulic power is engaged.

OPERATION

This Post Hole Digger was designed for one-man operation from the tractor seat. It is the responsibility of the operator to see that no one else is within twenty-five feet (25') of the digger when it is started.

- Set tractor brakes.
- Take tractor out of gear. Shift to "Park" (if applicable).
- Lower auger point slowly to the ground with the hydraulics disengaged.
- With the auger point lowered to the ground, set the engine speed to idle, then engage the hydraulic power. Make sure the auger point is on the ground before engaging the hydraulic oil flow.
- Increase the speed as required so dirt is conveyed from the hole.
- When digging holes on a slope, always have the post hole digger facing uphill.
- Only use a skid steer equipped with a ROPS cab or roll-over protective structure.



SAFETY . . .
YOU CAN LIVE WITH IT!



OPERATING INSTRUCTIONS (continued)

OPERATION (continued)

- Use particular care when working on inclines and hill-sides.
- Avoid holes, ditches, and obstructions which may cause skid steer loader to tip.
- Never allow anyone to walk or work under a raised loader.
- Operate the loader controls smoothly, avoiding jerky operation.
- Be sure anyone operating the loader is aware of safe operation and potential hazards. Read and observe safety recommendations in loader manual.
- Operate loader from operator's seat only. Remain at controls until operating cycle is complete.
- Do not lift or carry anyone on loader or in bucket or attachment.
- Travel slowly over rough ground or when making turns.
- Drive slowly through gates and doors.
- Lower bucket or attachment to ground when loader is unattended.



Beware of low electrical wires when loader is raised. Serious injury or death can result if contact is made.

DIGGING A HOLE: Position the tractor so that the auger point is placed where the hole is to be. Lower the auger so that the point touches the ground.

If the auger tilts too far forward or to the rear, lift auger off the ground and correct by re-lowering the auger. In some cases, it may be necessary to move the tractor slightly. Be careful not to bend the auger.

The Hydraulic Post Hole Digger is designed to operate in both forward and reverse rotation simply by reversing the oil flow. This works to the operator's advantage when encountering a root or rock and the auger stalls.

For those unfamiliar with using a post hole digger, it is best to operate the tractor engine at an idle speed. Tilt the loader bucket so that it is parallel with the ground. Position the tractor and auger where you want to dig and lower the loader or 3 pt. boom until the auger point touches to ground. Engage the auger and slowly lower the loader or boom, giving the auger ample time to dig without stalling.



KEEP ALL PERSONS AWAY FROM THE ROTATING AUGER.

DO NOT LET THE AUGER SCREW ITSELF INTO THE GROUND! Auger must dig with the dirt breaking up and being carried to the top by the auger flighting.

Once the hole is dug to the desired depth raise the auger while rotating to bring the dirt out of the hole. To get a clean hole, it is sometimes best to lower the auger into the hole with the auger turning and then, when at the bottom, stop the rotation and raise the auger while not turning. This brings the dirt up with little left in the hole.

For best results, allow the digger to dig about half the required depth, then lift it partially out of the hole to remove dirt and then re-enter hole and finish to the desired depth.



Never locate auger by putting hands on auger, gearbox, or boom when there is any sign of rotation of the auger or if the tractor is running.



Do not shovel dirt away from a turning auger, as the shovel can be caught by the auger and thrown. Do not allow anyone to stand behind or to the side of an operating auger. ALL persons should be at least 25 feet away.

OPERATING INSTRUCTIONS (continued)

OPERATION (continued)



Remain on the tractor seat while operating the post hole digger. Assisting the machine by hand can result in possible injury or death.

NOTE: Be sure auger is completely retracted from the hole before attempting to move the tractor.

Once the auger is digging a hole, the **tractor cannot be moved**. Make sure brake is set securely. If the tractor does move while the auger is in a hole, **damage to the gearbox or auger can result (not covered by warranty)**.

Cutting edges and screw type center point are replaceable. They should be sharpened or replaced when worn. In hard digging conditions, a fishtail type center point is more aggressive and is recommended.

NOTE: If you have a rocky or large root soil condition, it is recommended that a heavy duty auger be used.

If you encounter rocks or roots that catch the auger and cause shear bolts to break, then remove the auger from the hole and use a large, heavy pry bar to break up the obstructing rock. A large root may have to be chopped to remove.

If auger becomes lodged below ground, **DO NOT** attempt to lift auger out of ground by hydraulic lift power alone. Reverse the rotation of the auger by several turns.

Extreme rocking or lifting loads while trying to clear stuck augers can cause auger, gearbox, or boom failure.



Underground utilities – Contact appropriate agencies to determine if hazardous items are buried under the digging site BEFORE DIGGING! Be certain underground utilities have been called to locate underground electric, gas, telephone, and other lines. Check your telephone book for calling instructions. Be sure post hole digger operator is properly informed. WHEN IN DOUBT, DO NOT DIG!



Beware of lift clearance when raising loader to maximum height.



A free-swinging auger can be hazardous during transport. Remove auger or stabilize by tying to loader frame. Always keep loader low during transport.



Road travel at a high rate of speed with the loader raised could cause a tractor rollover. Serious injury or death could result. Always keep loader low and slow down for turns. Use extra care on side hills.

Safety is a primary concern in the design and manufacture of our products. Unfortunately, our efforts to provide safe equipment can be wiped out by a single careless act of an operator.

It has been said, "The best safety device is an informed, careful operator." We ask you to be that kind of an operator.

TRANSPORTING

Pay particular close attention to the Safety Messages regarding transport. Avoid unnecessary injuries and equipment damage by exercising cautious, conscientious travel procedures.

Attaching the implement to the tractor increases the overall length of the working unit. Allow additional clearance for the implement to swing when turning.

DO NOT OPERATE AUGER DURING TRANSPORT.

OWNER SERVICE

The information in this section is written for operators who possess basic mechanical skills. Should you need help, your dealer has trained service technicians available. For your protection, read and follow all safety information in this manual.

! WARNING! !

- ▲ Lower post hole digger to ground or block securely, turn engine off, remove key and relieve hydraulic line pressure before performing any service or maintenance. Never leave equipment unattended with engine running.
- ▲ Before working underneath, raise auger to desired position and block securely. Hydraulic system leakdown and failure of mechanical or hydraulic system can cause equipment to drop.
- ▲ Keep all persons away from operator control area while performing adjustments, service or maintenance.

ROUTINE MAINTENANCE

DAILY CHECKS:

1. Check that all bolts, nuts, and screws are tight. Checking the bolts and nuts on the cutting blades is particularly important in rocky soil.
2. Check daily the level of the gearbox oil and top up to the correct level. Check for gearbox oil leaks. It should be noted that no warranty claim can be submitted on a gearbox that has run dry. It is essential that the gearbox is kept correctly filled with gearbox oil.
3. Check the wear on the cutting blades. Sharpen them routinely with an angle grinder or replace when worn down too far. Keep at least two sets of cutting blades, bolts, and nuts as spares.

MAINTENANCE

Check the pins at the ends of the loader arms. Make sure they are locked in place with the linchpins or cotter pins.

Periodically check all bolts to make sure they are tight. Check hydraulic hoses. Make sure they are not chafed or pinched. Replace any damaged hose.

Check hydraulic hoses and fittings for leaks. Repair any leaks immediately. Never use your hand to check for a hydraulic leak when system is under pressure.

Replace any worn or damaged parts immediately. Do not use post hole digger attachment with any damaged parts.

Lubricate loader as per instructions in loader manual. Check chain links for wear (Models 814H and 824H) – replace chain if necessary. Replace safety signs and instruction decals if damaged or missing.

AT THE END OF THE SEASON:

1. Drain and change the oil in your gearbox.
2. Check and replace, where necessary, blades, bolts, nuts on the machine.
3. Clean machine and touch up any rust spots that may have appeared.
4. Replace any safety signs if damaged or painted over.
5. Keep all shields in place. Order new shields if damaged or missing.
6. Keep cutting edges sharp. Sharp cutting edges dig easier and better. Outer cutting edges on larger augers wear faster than inner cutting edges; switching teeth will even wear.
7. Store implement in clean, dry location.

SPECIFICATIONS

MODELS 614, 714 and 814

Low Volume Drive Motor

Maximum Auger Diameter 14"
 Minimum Hydraulic Flow 5 gpm
 Maximum Hydraulic Flow 12 gpm
 Maximum Operating Pressure 3000 psi
 700 ft. lbs. maximum torque at spindle at 2500 psi

MODELS 624, 724, 824 and 924

High Volume Drive Motor

Maximum Auger Diameter 24"
 Minimum Hydraulic Flow 10 gpm
 Maximum Hydraulic Flow 20 gpm
 Maximum Operating Pressure 3000 psi
 1000 ft. lbs. maximum torque at spindle at 2500 psi

ALL MODELS

Digging depth 42"
 Gearbox ration 3:18-1
 Motor has 3000 psi relief and shuttle valve to recirculate high pressure oil on rapid start/stop.

Typical Hydraulic GPM and corresponding auger RPM

MODELS 614H/714H/814H		MODELS 624H/724H/824H/924H	
FLOW GPM	AUGER RPM	FLOW GPM	AUGER RPM
5	47	10	58
6	56	12	70
7	66	14	81
8	75	16	93
9	84	18	105
10	94	20	116

TROUBLE-SHOOTING GUIDE

PROBLEM: AUGER WILL NOT DIG

Possible Solutions:

- Teeth dull – sharpen or replace.
- Ground too dry and hard – order optional fishtail point (#170802) or optional down force kit, or wait until it rains.
- Auger turning too fast and bouncing – reduce speed.
- Tall grass has wrapped around auger teeth – remove.
- Auger encountering rocks, roots, or other obstruction – lift auger from hole and inspect.
- Auger teeth improperly positioned – see operator's manual for proper tooth pattern.

PROBLEM: AUGER DIGS SO FAR, BUT WILL NOT DIG DEEPER

Possible Solutions:

- See solutions for #1 above.
- Auger encountering soil hardpan layer.
- Tractor hydraulic system may be faulty – consult tractor dealer.
- Soil could have hardpan layer 6"-10" below surface – use optional fishtail point (#170802) or optional down force kit (see list of optional equipment).

PROBLEM: POST HOLE DIGGER SWAYS SIDE TO SIDE

Possible Solutions:

- No sway bars or sway blocks on tractor – add same.
- Lift arms not adjusted evenly – adjust lift arms.
- Post hole digger is mounted with excessive looseness in the connecting points – use proper size pins or bushings. Check mounting bolts or clamps.
- Auger is encountering rocks or roots or other foreign objects – remove object from hole or change location.
- Loader mount is loose on tractor.
- Operating at high rpm.

PROBLEM: BENT AUGER FLIGHTING OR BENT AUGER

Possible Solutions:

- Tractor moved while auger was turning in hole – always set brakes on tractor and make sure it is out of gear.
- Operator moved tractor with auger in hole to try and straighten a hole being dug at an angle.
- Auger encountering rocks, roots, or other obstruction – lift auger from hole and inspect.
- Outer edge of auger flighting is bending due to contact with rocks or roots – use heavy duty auger with thicker flighting.

PROBLEM: AUGER SCREWS ITSELF INTO THE GROUND

Possible Solutions:

- Operator did **NOT** ease 3-pt. hitch to ground slowly.
- Faulty 3-pt. hitch hydraulic system on tractor.
- Draft control is not in **OFF** position.
- Tractor is too small to handle digger.
- Excessive down pressure being applied with loader.
- Faulty hydraulic system on loader.

PROBLEM: HYDRAULIC OIL OVERHEATS

Possible Solutions:

- Hydraulic oil level in tractor or skid steer reservoir may be low.
- Hydraulic oil or oil filter in tractor or skid steer may be dirty. Change oil and filter according to tractor manufacturer's recommendations.
- Hydraulic oil reservoir of tractor or skid steer may be small. Allow time for oil to cool down.

TROUBLE-SHOOTING GUIDE (continued)

PROBLEM: 3 PT. POST HOLE DIGGER WON'T LIFT HIGH ENOUGH

Possible Solution:

- Tractor is a "low profile model" (one that is low to the ground). Due to the low height of the tractor, the digger must be raised higher to have the bottom of the auger clear the ground. Generally, low profile model tractors can only use 30 inch long augers (standard auger length is 42"). Use a different tractor or purchase 30" long augers.

PROBLEM: HYDRAULIC HOSE FAILURE

Possible Solutions:

- Hydraulic relief pressure setting is very high and may cause hydraulic hose failure.
- Hoses are worn or frayed – replace hose.
- Hose rating may be too low for hydraulic system pressure. Replace with higher rated hoses.
- Hose being pinched – reroute hose and refasten.

PROBLEM: AUGER VEERS OFF AT AN ANGLE WHILE DIGGING.

Possible Solutions:

- Auger may have encountered a rock or large root. Hole may have to be relocated.
- Post hole digger mount may not be properly latched on tractor or skid steer loader. Check lock pins.
- Operator has moved slightly while digging hole. Always set brakes and use extra care on slopes.
- Operator applied excessive down pressure with loader causing front of tractor to raise off ground and then shifted sideways

PROBLEM: AUGER STALLS

Possible Solutions:

- Auger is encountering rocks or roots or other foreign object – remove object or change hole location.
- Hydraulic system may not be supplying rated pressure (usually 1500 to 2250 PSI). Consult your dealer.

PROBLEM: GEARBOX FAILURE

Possible Solutions:

- No oil in gearbox.
- Oil not changed per instructions.
- Bent output shaft is due to operator moving tractor when auger is in hole.

PROBLEM: AUGER ROTATES TOO SLOW

Possible Solutions:

- Hydraulic system on tractor too small for hydraulic post hole digger model being used.
- Hydraulic system may not be delivering its rated volume of oil due to wear. Hydraulic pump may need to be repaired.

PROBLEM: AUGER ROTATES TOO FAST

Possible Solutions:

- Hydraulic system of tractor or skid steer too large for hydraulic post hole digger unit.

PROBLEM: GEARBOX OVERHEATING

Possible Solutions:

- Low on lubricant – fill to proper level.
- Improper type lubricant – replace with proper lubricant.

PROBLEM: AUGER BOLTS SHEAR ON GEARBOX OUTPUT SHAFT

Possible Solutions:

- Auger is encountering rocks, roots or other obstruction.
- Bolts were not tightened properly.
- Operator is rapidly reversing hydraulic control valve – putting excessive shock loads on bolts.

AUGER TEETH MOUNTING PATTERNS



FIG.
B
6"



FIG.
C
9"

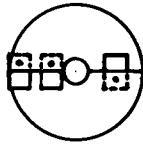

FIG.
D
12" & 14"

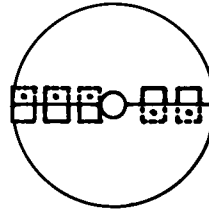

FIG.
E
18"

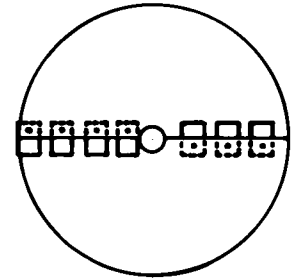
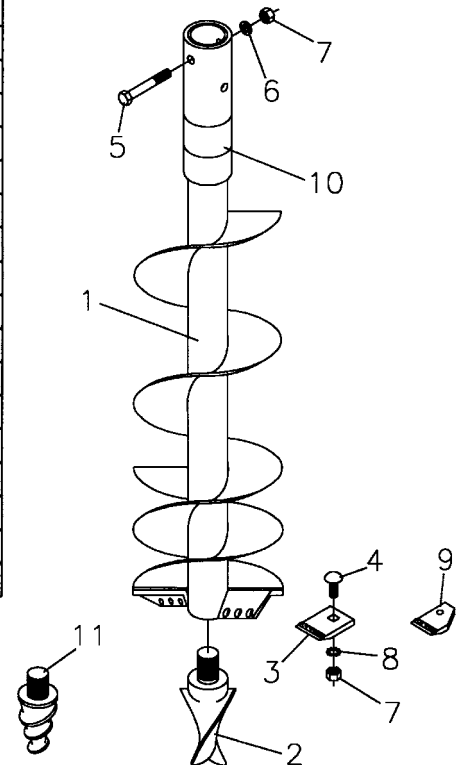

FIG.
F
24"

HEAVY DUTY AUGER PARTS LIST

Ref. No.	Part No.	Description	No. Req'd.
1	706150	6" HD Single Flight Auger (Complete)	Opt.
	706155	6" HD Double Flight Auger "	Opt.
	706109	9" HD Single Flight Auger "	Opt.
	706009	9" HD Double Flight Auger "	Opt.
	706112	12" HD Single Flight Auger "	Opt.
	706012	12" HD Double Flight Auger "	Opt.
	706033	14" HD Single Flight Auger "	Opt.
	706037	14" HD Double Flight Auger "	Opt.
	706070	18" HD Double Flight Auger "	Opt.
	706075	24" HD Double Flight Auger "	Opt.
2	170802	Fishtail Auger Point	1
3	706021	Red Claw Digger Tooth	Var.
4	2503166	Bolt 1/2"-13NC x 1 1/4" Carriage Head	Var.
5	2503109	Bolt 1/2"-13NC x 3 1/2" Hex Head	2
6	2502002	Washer 1/2" Springlock	2
7	2500003	Nut 1/2" Full Hex	Var.
8	2502003	1/2" External Star Lockwasher	Var.
9	171903*	Auger Cutting Edge (6" only)	2
N/S	2503178*	Bolt 3/8"-16NC x 1 1/4" Carriage Head (6" only)	2
N/S	2502014*	3/8" External Star Washer (6" only)	2
N/S	2500004*	Nut 3/8" Full Hex (6" only)	2
10	101131	Safety Sign - Danger (Guard Missing)	1
11	210007	Optional Screw Type Auger Point	1

*Old Style 6" Augers (prior to June 2000) - New 6" Augers use Red Claw Digger Tooth (Item #3)



HYDRAULIC PHD GEARBOX PARTS LIST

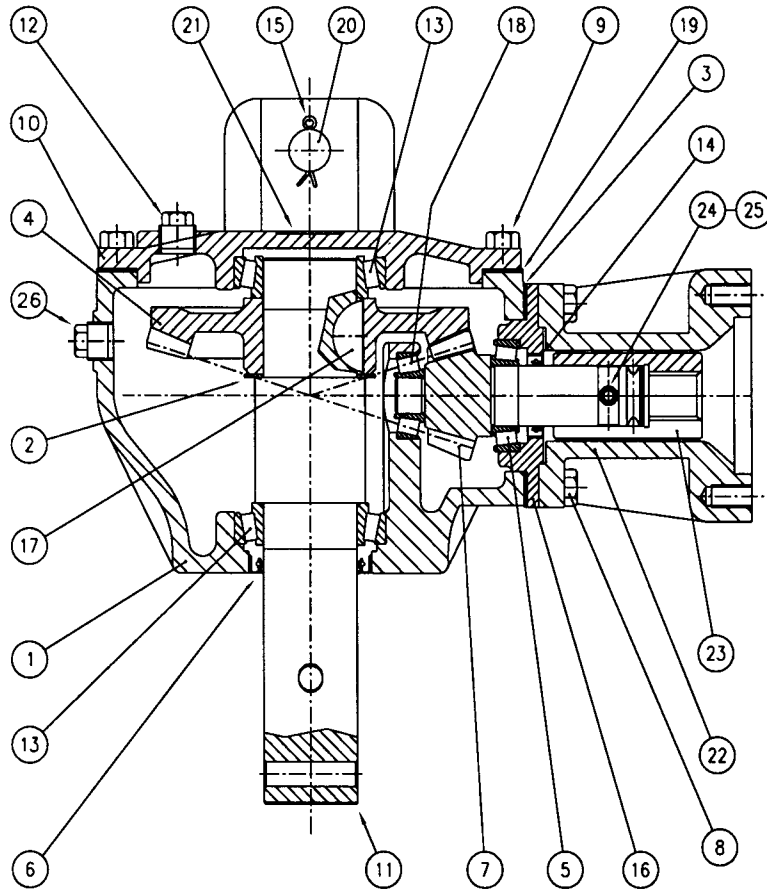

Ref. No.	Worksaver Part No.	Description	Com. Code No.	No. Req'd.
	706405	Complete Gearbox Only (less Flange Assembly)	9.196.000.00	1
	702141	Flange Assembly (Items #8 & #22-#25)	A.196.502	1
1	Not Available	Casting & Machining	0.196.0300.00	1
2	706406	Shim Kit (51.1 x 63)	0.196.7500.00	1
3	706407	Gasket Kit (81.5 x 118)	0.196.7300.00	1
4	706408	Crown Gear Z35 M5.08	0.196.6000.00	1
5	706409	Roller Bearing LM67048 - LM67010	8.0.9.02531	1
6	706410	Dust Lip 50.8 x 66.62 x 7.92	8.7.1.02529	1
7	706411	Pinion Z11 M5.08	0.196.5000.00	1
8	702148	Bolt M10 x 40 Hex Head Gr. 8.8	8.1.1.00745	4
9	702149	Bolt M10 x 30 Hex Head Gr. 8.8	8.1.1.00073	6
10	702150	Top Plate	0.196.1300.00	1
11	706412	Output Shaft	0.196.3001.00	1
12	702147	1/2" Gas Solid Plug	8.6.5.00203	1
13	706413	Roller Bearing LM104949 - LM104911	8.0.9.02532	2
14	706414	Dust Lip 31.75 x 44.5 x 7.92	8.7.1.02530	1
15	702153	Cotter Pin 5 x 40	8.4.7.00671	2
16	706415	Cover	0.196.1301.00	1
17	706416	Woodruff Key 7.94 x 16.28	0.196.7000.00	1
18	706417	Roller Bearing LM11910 - LM11949	8.0.9.02533	1
19	706418	Gasket Kit (190 x 224.5)	0.196.7200.00	1
20	706419	Pivot Shaft	0.196.3000.00	1
21	Not Available	Name Plate	0.124.7135.00	1
22	702142	Extension	0.196.1302.00	1
23	702143	Bushing Grooved	0.196.7001.00	1
24	702144	Pin 6 x 45 DIN1481	8.4.5.02705	1
25	702145	Pin 10 x 45 DIN1481	8.4.5.02706	1
26	702146	3/8" Gas Solid Plug	8.6.5.00006	1

614H & 624H PARTS LIST

For Units Manufactured
After S/N 03080001

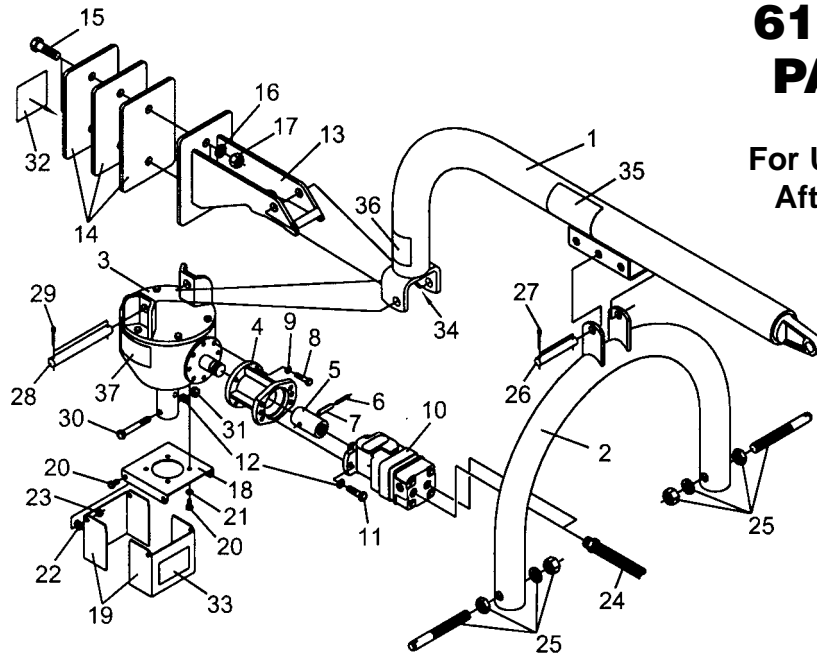

Ref. No.	Part No.	Description	No. Req'd.
1	705001	Boom Weldment, Heavy Duty	1
2	3814007	Yoke Weldment	1
3	706405	Gearbox	1
	702141	Flange Assembly (Includes Items #4 thru #8)	1
4	702142	Extension	1
5	702143	Bushing, Splined	1
6	702144	Pin 6 x 45, Spring	1
7	702145	Pin 10 x 45, Spring	1
8	702148	Bolt M10 x 40 Hex Head Gr. 8.8	4
9	2502019	Washer 10MM Springlock	4
10	2505615	Hydraulic Motor (614H)	1
	2505617	Hydraulic Motor (624H)	1
11	2503265	Bolt 1/2"-13NC x 1 3/4" Hex Head Gr.5	2
12	2502002	Washer 1/2" Springlock	4
13	702056	Counterweight Bracket	1
14	702058	Endplate, Counterweight	3
15	2503085	Bolt 3/4"-10NC x 2 1/2" Hex Head Gr.5	2
16	2502001	Washer 3/4" Springlock	2
17	2500002	Nut 3/4"-10NC Full Hex	2
18	706091	Shield Base	1
19	706094	Flip Down Shield	2
20	2503030	Bolt 3/8"-16NC x 3/4" Hex Head Gr.2	8
21	2502008	Washer 3/8" Springlock	4
22	2501004	Washer 3/8" Flat	4
23	2500055	Nut 3/8"-16NC Hex Stamplock	4
24	2505576	Hydraulic Hose 1/2" x 60"	2
25	590071	Hitch Pin (AK-479)	2
26	3814019	Boom Adjustment Pin	1
27	2504121	Cotter Pin 3/16" x 1 1/2"	2
28	706096	Gearbox Pin	1
29	706097	Cotter Pin 3/16" x 2"	2
30	2503109	Bolt 1/2"-13NC x 3 1/2" Hex Head Gr.2	2
31	2500003	Nut 1/2"-13NC Full Hex	2
32	101122	Safety Sign-Warning (Hi Pressure)	1
33	101186	Safety Sign-Warning (Shields)	2
34	101015	Safety Sign-PHD Instructions	1
35	101032	Safety Sign-Danger (PH Digger)	1
36	101130	Safety Sign-Danger (Rotating Parts)	1
37	101188	Safety Sign-Gearbox Notice	1

714H & 724H PARTS LIST

For Units Manufactured
After S/N 030800001

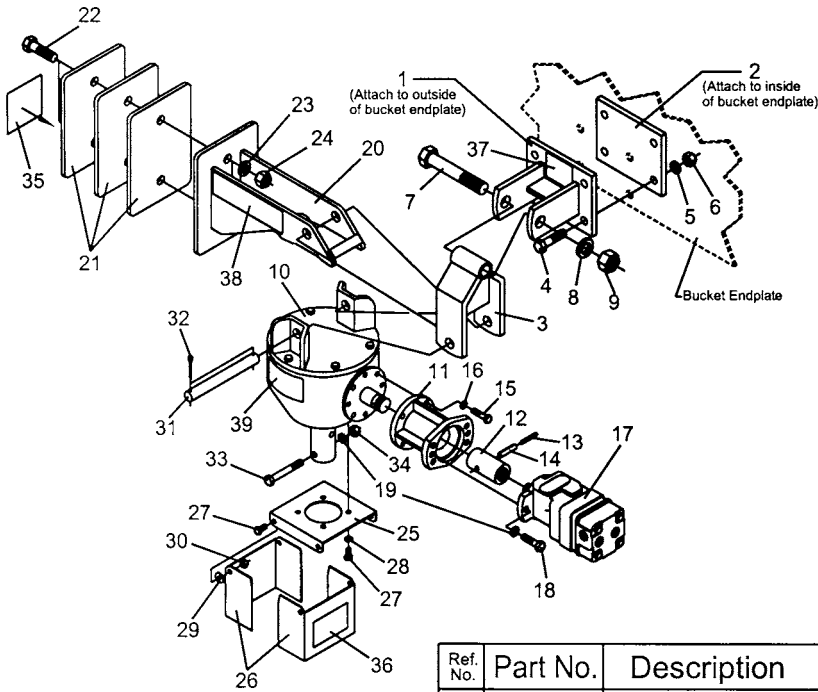

Ref. No.	Part No.	Description	No. Req'd.
1	830316	Mounting Bracket Weldment	1
2	830210	Mounting Plate	1
3	702040	Pivot Bracket Weldment	1
4	2503088	Bolt 5/8"-11NC x 2 1/2" Hex Head Gr.5	4
5	2502007	Washer 5/8" Springlock	4
6	2500013	Nut 5/8"-11NC Full Hex	4
7	2503257	Bolt 1"-8NC x 6" Hex Head Gr.5	1
8	2502009	Washer 1" Springlock	1
9	2500001	Nut 1"-8NC Full Hex	1
10	706405	Gearbox	1
	702141	Flange Assembly (Includes Items #11 thru #15)	1
11	702142	Extension	1
12	702143	Bushing, Splined	1
13	702144	Pin 6 x 45, Spring	1
14	702145	Pin 10 x 45, Spring	1
15	702148	Bolt M10 x 40 Hex Head Gr. 8.8	4
16	2502019	Washer 10MM Springlock	4
17	2505615	Hydraulic Motor (714H)	1
	2505617	Hydraulic Motor (724H)	1
18	2503265	Bolt 1/2"-13NC x 1 3/4" Hex Head Gr.5	2
19	2502002	Washer 1/2" Springlock	4
20	702056	Counterweight Bracket	1
21	702058	Endplate, Counterweight	3
22	2503085	Bolt 3/4"-10NC x 2 1/2" Hex Head Gr.5	2
23	2502001	Washer 3/4" Springlock	2
24	2500002	Nut 3/4"-10NC Full Hex	2
25	706091	Shield Base	1
26	706094	Flip Down Shield	2
27	2503030	Bolt 3/8"-16NC x 3/4" Hex Head Gr.2	8
28	2502008	Washer 3/8" Springlock	4
29	2501004	Washer 3/8" Flat	4
30	2500055	Nut 3/8"-16NC Hex Stamplock	4
31	706096	Gearbox Pin	1
32	706097	Cotter Pin 3/16" x 2"	2
33	2503109	Bolt 1/2"-13NC x 3 1/2" Hex Head Gr.2	2
34	2500003	Nut 1/2"-13NC Full Hex	2
35	101122	Safety Sign-Warning (Hi Pressure)	1
36	101186	Safety Sign-Warning (Shields)	2
37	101015	Safety Sign-PHD Instructions	1
38	101130	Safety Sign-Danger (Rotating Parts)	1
39	101168	Safety Sign-Gearbox Notice	1

814H & 824H PARTS LIST

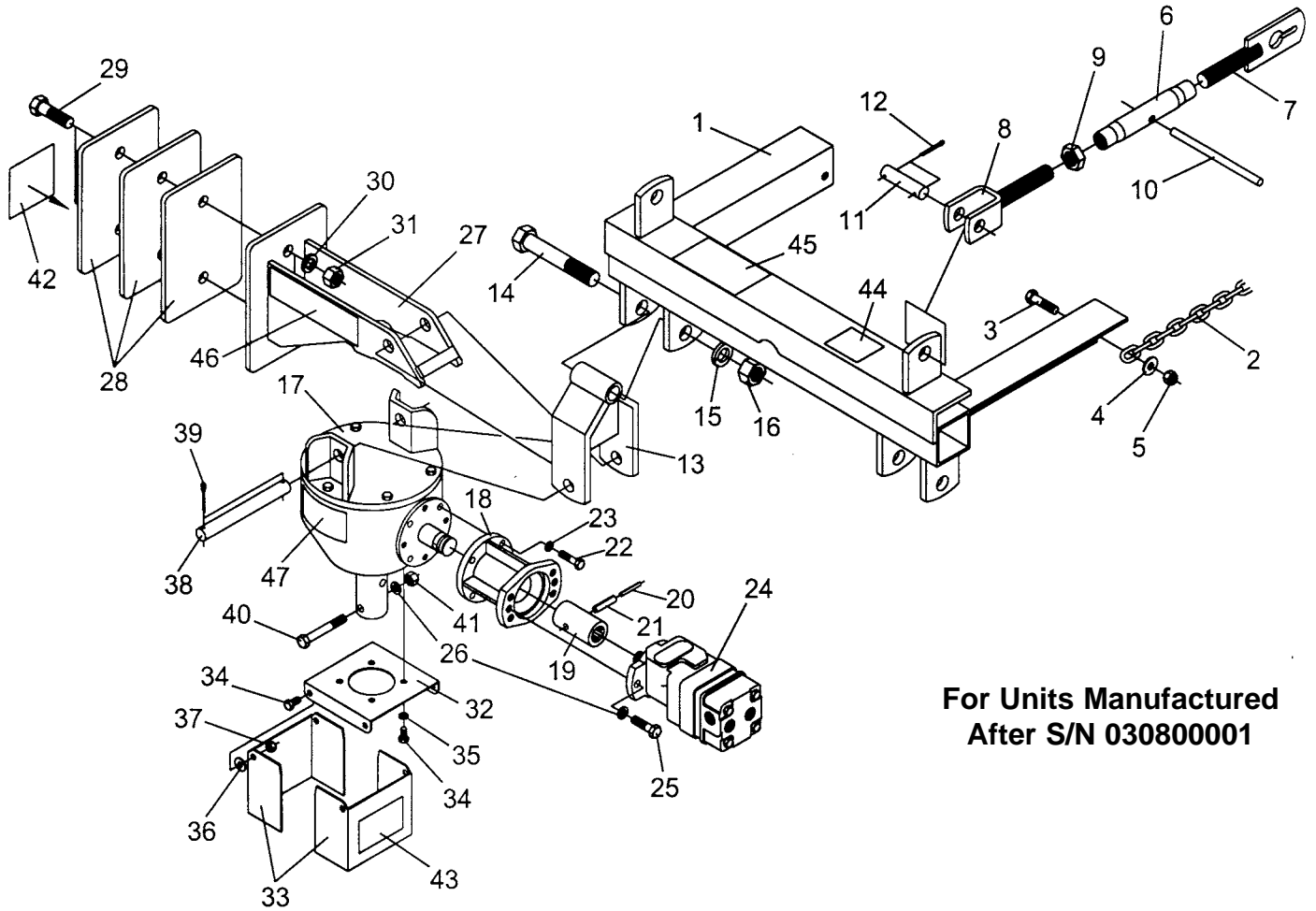

**For Units Manufactured
After S/N 03080001**

Ref. No.	Part No.	Description	No. Req'd.	Ref. No.	Part No.	Description	No. Req'd.
1	702001	Clamp-On Weldment	1	24	2505615	Hydraulic Motor (814H)	1
2	830406	Chain, 5/16" Proof Coil x 5 Ft.	2		2505617	Hydraulic Motor (824H)	1
3	2503118	Bolt 1/2"-13NC x 2" Hex Head Gr.5	2	25	2503265	Bolt 1/2"-13NC x 1 3/4" Hex Head Gr.5	2
4	2501003	Washer 1/2" Flat	2	26	2502002	Washer 1/2" Springlock	4
5	2500039	Nut 1/2"-13NC Hex Nylock	2	27	702056	Counterweight Bracket	1
	831215	Complete Turnbuckle Assembly (#6 thru #10)	2	28	702058	Endplate, Counterweight	3
6	590277	Barrel	2	29	2503085	Bolt 3/4"-10NC x 2 1/2" Hex Head Gr.5	2
7	830412	Threaded Stub, LH	2	30	2502001	Washer 3/4" Springlock	2
8	830410	Threaded Stub, RH	2	31	2500002	Nut 3/4"-10NC Full Hex	2
9	2500024	Nut 1"-8NC Jam Hex	2	32	706091	Shield Base	1
10	590145	Handle	2	33	706094	Flip Down Shield	2
11	831229	Pin, Turnbuckle	2	34	2503030	Bolt 3/8"-16NC x 3/4" Hex Head Gr.2	8
12	2504121	Cotter Pin 3/16" x 1 1/2"	4	35	2502008	Washer 3/8" Springlock	4
13	702040	Pivot Bracket Weldment	1	36	2501004	Washer 3/8" Flat	4
14	2503257	Bolt 1"-8NC x 6" Hex Head	1	37	2500055	Nut 3/8"-16NC Hex Stamplock	4
15	2502009	Washer 1" Springlock	1	38	706096	Gearbox Pin	1
16	2500001	Nut 1"-8NC Full Hex	1	39	706097	Cotter Pin 3/16" x 2"	2
17	706405	Gearbox	1	40	2503109	Bolt 1/2"-13NC x 3 1/2" Hex Head Gr.2	2
	702141	Flange Assembly (Includes Items #18 thru #22)	1	41	2500003	Nut 1/2"-13NC Full Hex	2
18	702142	Extension	1	42	101122	Safety Sign-Warning (Hi Pressure)	1
19	702143	Bushing, Splined	1	43	101186	Safety Sign-Warning (Shields)	2
20	702144	Pin 6 x 45, Spring	1	44	101015	Safety Sign-PHD Instructions	1
21	702145	Pin 10 x 45, Spring	1	45	101032	Safety Sign-Danger (PH Digger)	1
22	702148	Bolt M10 x 40 Hex Head Gr. 8.8	4	46	101130	Safety Sign-Danger (Rotating Parts)	1
23	2502019	Washer 10MM Springlock	4	47	101188	Safety Sign-Gearbox Notice	1

924H PARTS LIST

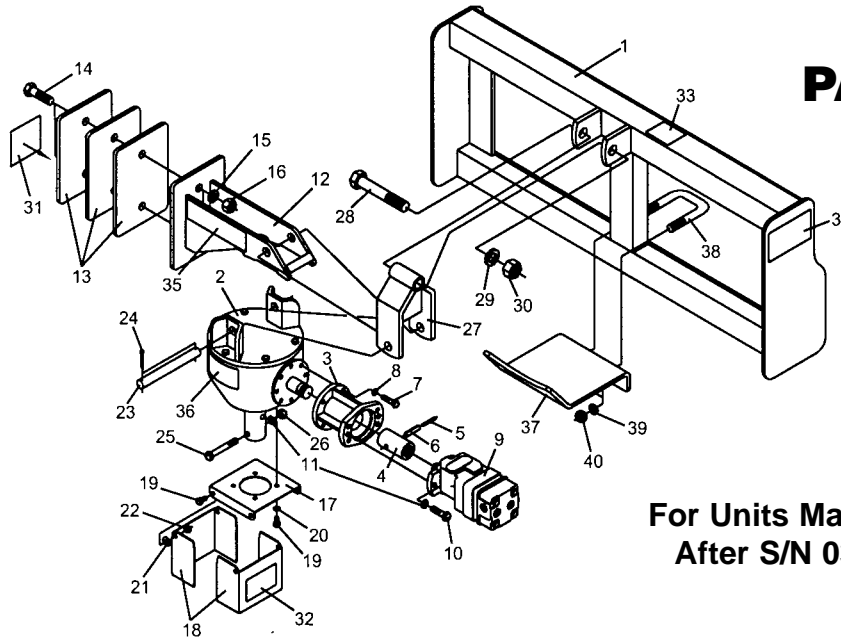

For Units Manufactured
After S/N 03080001

Ref. No.	Part No.	Description	No. Req'd.
1	702121	Main Frame Weldment	1
2	706405	Gearbox	1
	702141	Flange Assembly (Includes Items #3 thru #7)	1
3	702142	Extension	1
4	702143	Bushing, Splined	1
5	702144	Pin 6 x 45, Spring	1
6	702145	Pin 10 x 45, Spring	1
7	702148	Bolt M10 x 40 Hex Head Gr. 8.8	4
8	2502019	Washer 10MM Springlock	4
9	2505617	Hydraulic Motor	1
10	2503265	Bolt 1/2"-13NC x 1 3/4" Hex Head Gr.5	2
11	2502002	Washer 1/2" Springlock	4
12	702056	Counterweight Bracket	1
13	702058	Endplate, Counterweight	3
14	2503085	Bolt 3/4"-10NC x 2 1/2" Hex Head Gr.5	2
15	2502001	Washer 3/4" Springlock	2
16	2500002	Nut 3/4"-10NC Full Hex	2
17	706091	Shield Base	1
18	706094	Flip Down Shield	2
19	2503030	Bolt 3/8"-16NC x 3/4" Hex Head Gr.2	8
20	2502008	Washer 3/8" Springlock	4
21	2501004	Washer 3/8" Flat	4
22	2500055	Nut 3/8"-16NC Hex Stamplock	4
23	706096	Gearbox Pin	1
24	706097	Cotter Pin 3/16" x 2"	1
25	2503109	Bolt 1/2"-13NC x 3 1/2" Hex Head Gr.2	2
26	2500003	Nut 1/2"-13NC Full Hex	2
27	702040	Pivot Bracket Weldment	1
28	2503257	Bolt 1"-8NC x 6" Hex Head Gr.5	1
29	2502009	Washer 1" Springlock	1
30	2500001	Nut 1"-8NC Full Hex	1
31	101122	Safety Sign-Warning (Hi Pressure)	1
32	101186	Safety Sign-Warning (Shields)	2
33	101015	Safety Sign-PHD Instructions	1
34	101032	Safety Sign-Danger (PH Digger)	1
35	101130	Safety Sign-Danger (Rotating Parts)	1
36	101188	Safety Sign-Gearbox Notice	1
37	702127	Gearbox Cradle	1
38	940009	U-Bolt 5/8"-11NC 3" ID x 4"	1
39	2502007	Washer 5/8" Spring Lock	2
40	2500013	Nut 5/8"-11NC Full Hex	2

⚠ SAFETY PRECAUTIONS ⚠

**MOST ACCIDENTS OCCUR BECAUSE OF NEGLIGENCE OR CARELESSNESS.
AVOID NEEDLESS ACCIDENTS BY FOLLOWING ALL OF THE SAFETY PRECAUTIONS LISTED BELOW.**

- Machinery should be operated only by those who are responsible and are authorized to do so.
- Stop the engine, lower all equipment, lock the brakes, and remove the ignition key before dismounting from the tractor.
- Never stand between tractor and implement while tractor is being backed to hitch.
- Loose fitting clothing should not be worn, to avoid catching on various parts.
- Detach implement in area where children normally do not play.
- When performing adjustments or maintenance on an implement, first lower it to the ground or block it securely at a workable height.
- Only a qualified operator should be permitted on tractor when in operation; no riders allowed.
- Make certain everyone is in the clear before starting tractor or raising or lowering equipment.
- Operate the tractor and implement only while seated in the driver's seat.
- Reduce speed when transporting mounted implements to avoid bouncing and momentary loss of steering control.
- A heavy load can cause instability of the tractor. Use extreme care during road travel. Slow down on turns and watch out for bumps. Tractor may need front counterweights to counter-balance the weight of the implement.
- Reduce speed on hillsides or curves so there is no danger of tipping.
- Avoid driving too close to the edge of ditches or creeks.
- Do not transport implement on public roads without reflectors and slow moving vehicle emblem in daylight and with approved warning lights at night and other periods of poor visibility.
- Due to the width of some implements, use extra caution on highways, farm roads, and when approaching gates.
- Always be sure the implement is in the proper position for transport.
- Keep alert and watch the front as well as the rear when working with the implement.

OWNER'S/ OPERATOR'S MANUAL

MODEL NO.'s

614H

624H

714H

724H

814H

824H

924H

(#030800001 AND UP)

NOVEMBER 2003

HYDRAULIC POST HOLE DIGGERS

**WHEN ORDERING REPAIR PARTS,
ALWAYS GIVE THE
FOLLOWING INFORMATION:**

1. PART NUMBER
2. PART DESCRIPTION
3. MODEL NUMBER
4. NAME OF ITEM

**MAKE EVERY DAY
A HOLIDAY
FROM ACCIDENTS!**

WORKSAVER, INC.

P.O. BOX 100 LITCHFIELD, IL 62056-0100 (217) 324-5973
WEB: <http://www.worksaver.com> E-MAIL: sales@worksaver.com